

深圳市瑞隆源电子有限公司 Shenzhen RUILONGYUAN Electronics Co.,Ltd.			
产品名称 Product name	低压电涌保护器 Low-voltage Surge Protective Devices	产品型号 Product type	TAL22010D
文件编号 File serial number	SP-SPD-049	产品编码 Product code	10.20.00.0020
类别 Classification	<input type="checkbox"/> 参考阶段 Reference <input checked="" type="checkbox"/> 正式承认 Qualified	<input type="checkbox"/> 样品阶段 Sample <input type="checkbox"/> 工程变更 Changed	

TAL22010D

低压电涌保护器 技术规格书

Low-voltage Surge Protective Device Technical Specification

拟制:	Lucy	日期:	2022.10.12
Prepared by	_____	Date	_____
审核:	Charlie	日期:	2022.10.12
Reviewed by	_____	Date	_____
批准:	Robert	日期:	2022.10.12
Approved by	_____	Date	_____

深圳市瑞隆源电子有限公司
Shenzhen RUILONGYUAN Electronics Co.,Ltd.

目录 Catalogue

1.适用范围 Scope.....	4
2.术语 Glossary	4
3.结构尺寸 Structure and Dimensions	6
3.1 结构图 Structure.....	6
3.2 主要原材料明细 Main Material List	6
3.3 产品尺寸 Product Dimensions	7
3.4 电路图 Circuit Diagram	7
4.安规认证 Agency Approvals.....	8
5.环保 Environment.....	8
6.技术参数 Specifications	8
7.检验方法和标准 Inspection Method & Standards	9
8.安全预防措施 Safety Precautions.....	11
9.标示及包装 Marks and Package	12
10.产品批号&追溯号识别 Lot No. & Tracking No. System.....	13
11.储存条件和有效日期 Storage Conditions and Effective Date.....	13
12.有效性 Validity	13
12.1 修订协议 Agreement of Revision	13
12.2 有效性 Validity	13

1. 适用范围 Scope

TAL22010D 低压电涌保护器应用于户外路灯、景观灯、交通信号灯等照明电源的电涌保护，抑制和泄放因感应雷或低压配电系统内部所产生的过电流和过电压，保护用电设备免受损害。本产品适用于 110V-277V 的交流供电系统，采用差模的保护方式，使用软导线与外电路并联连接。

浪涌防护等级：

IEC61000-4-5 复合波冲击开路电压 10KV；

IEC/EN 61643-11 标称放电电流 5kA，最大放电电流 10kA，开路电压 20kV；

UL1449 标称放电电流 5kA。

TAL22010D low-voltage surge protector is applicable for the surge protection of lighting power supplies, such as outdoor street lamps, landscape lights, traffic signals and so on . It is used to suppress and discharge the overcurrent and overvoltage generated by induction lightning or low-voltage distribution systems, and protect electrical equipment from damage. This product is suitable for 110V-277V AC power supply system, using differential mode protection, the use of soft wire and external circuit parallel connection.

Surge protection level:

IEC61000-4-5 Impulse open circuit voltage 10 kV;

IEC/EN 61643-11 Nominal discharge current 5 kA, Maximum discharge current 10 kA, Impulse open circuit voltage 10 kV;

UL1449 Nominal discharge current 5 kA.

2. 术语 Glossary

2.1 浪涌 Surge

电路中电流、电势或能量的瞬态波。基于本标准，浪涌不包括在几个周期内因升高的工频电压所产生的瞬态过电压（TOV）。

A transient wave of current, potential or power in an electric circuit. For the purposes of this standard, surges do not include temporary over voltages (TOV) consisting of an increase in the power frequency voltage for several cycles.

2.2 电涌保护器 Surge Protective Device (SPD)

至少包含一个非线性元件，通过转移或抑制冲击电流来限制冲击电压的设备，且可以重复使用。

A device composed of at least one non-linear component and intended for limiting surge voltages on equipment by diverting or limiting surge current and is capable of repeating these functions as specified.

2.3 1.2/50 μ s 电压波形 1.2/50 μ s Voltage Wave

在开路情况下，视在波前时间为 1.2 μ s，且半峰值时间为 50 μ s 的冲击电压。

Voltage surge with a virtual front time of 1.2 μ s and a time to half-value of 50 μ s delivered across an open circuit.

2.4 8/20 μ s 电流波形 8/20 μ s Current Wave

短路情况下，视在波前时间为 8 μ s 且半峰值时间为 20 μ s 的冲击电流。

Current surge with a virtual front time of 8 μ s and a time to half-value of 20 μ s delivered into a short circuit.

- 2.5 标称系统电压 Nominal System Voltage
参照 ANSI C84.1 表 1，指定系统电压等级所对应的标称值。
A nominal value assigned to designate a system of a given voltage class in accordance with ANSI C84.1, Table 1.
- 2.6 最大持续工作电压 Maximum Continuous Operating Voltage (MCOV)
可连续地施加在 SPD 上的最大交流电压有效值或直流电压。
Maximum r.m.s. voltage, which may be continuously applied to the SPD's mode of protection.
- 2.7 实测限制电压 Measured Limiting Voltage (MLV)
施加规定波形和幅值的冲击时，在 SPD 端子处测得最大电压峰值。
Highest value of voltage that is measured across the terminals of the SPD during the application of impulses of specified wave shape and amplitude.
- 2.8 电压保护水平 Voltage Protection Level (Up)
由于施加规定陡度的冲击电压和规定幅值及波形的冲击电流而在 SPD 两端之间预期出现的最大电压。
Maximum voltage to be expected at the SPD terminals due to an impulse stress with defined voltage steepness and an impulse stress with a discharge current with given amplitude and wave shape.
- 2.9 参考试验电压 Reference Test Voltage (U_{REF})
用于 SPD 测试的电压有效值。它取决于 SPD 的保护模式、系统标称电压、系统结构和系统内的电压调整。
The r.m.s. value of voltage used for testing which depends on the mode of protection of the SPD, the nominal system voltage, the system configuration and the voltage regulation within the system.
- 2.10 标称放电电流 Nominal Discharge Current (I_n)
由厂家给出的，SPD 在经过 15 次 8/20 μ s 电流波形浪涌冲击后无损坏的电流峰值。
Peak value of the current, selected by the manufacturer, through the SPD having a current wave shape of 8/20 μ s where the SPD remains functional after 15 surges.
- 2.11 最大放电电流 Maximum Discharge Current (I_{max})
流过 SPD，具有为 8/20 μ s 波形电流的峰值，其峰值大小由厂家规定。 I_{max} 等于或大于 I_n 。
Crest value of a current through the SPD having an 8/20 μ s wave shape and magnitude according to the manufacturers specification. I_{max} is equal to or greater than I_n .
- 2.12 保护模式 Modes of Protection
在端子间保护保护元器件的电流路径，例如相对相、相对地、相对中线、中线对地。
An intended current path, between terminals that contains protective components, e.g. line-to-line, line-to-earth, line-to-neutral, neutral-to-earth.
- 2.13 外壳防护等级 (IP 代码) Degrees of Protection Provided by Enclosure (IP code)

外壳提供的防止触及及危险的部件、防止外界固体异物进入和/或防止水的进入壳内的防护程度。

Classification preceded by the symbol IP indicating the extent of protection provided by an enclosure against access to hazardous parts, against ingress of solid foreign objects and possibly harmful ingress of water.

2.14 开路电压 Open Circuit Voltage (Uoc)

在复合波发生器连接试品端口处的开路电压。

Open circuit voltage of the combination wave generator at the point of connection of the device under test.

3. 结构尺寸 Structure and Dimensions

3.1 结构图 Structure

产品结构：该产品设计类型为复合型，残压低；内部部件采用环氧树脂灌封，防水等级满足 IP67，外置引线与外电路连接。

Product Structure: The design type of the product is composite type, residual voltage low; The internal parts are sealed with epoxy resin, the waterproof level meets IP67; external leads are connected to the external circuit.

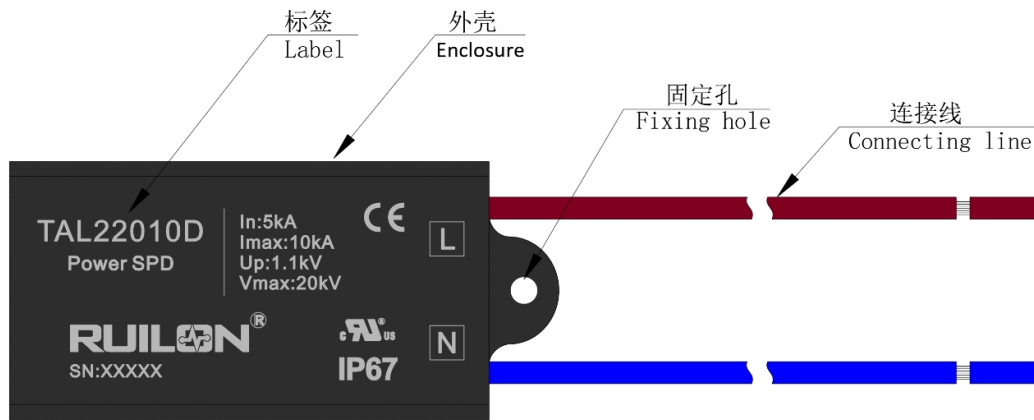

3.2 主要原材料明细 Main Material List

编号 NO.	零件名 Part Name	材质 Materials
1	外壳 Enclosure	塑料 Plastic
2	连接线 Connecting line	塑料、铜 Plastic、Cu
3	陶瓷气体放电管 Gas Discharge Tubes	陶瓷、铜 Ceramics、Cu
4	压敏电阻 Varistor	氧化锌 Zinc oxide
5	灌封材料 Embedding Material	环氧树脂 Epoxy resin

3.3 产品尺寸 Product Dimensions (mm)

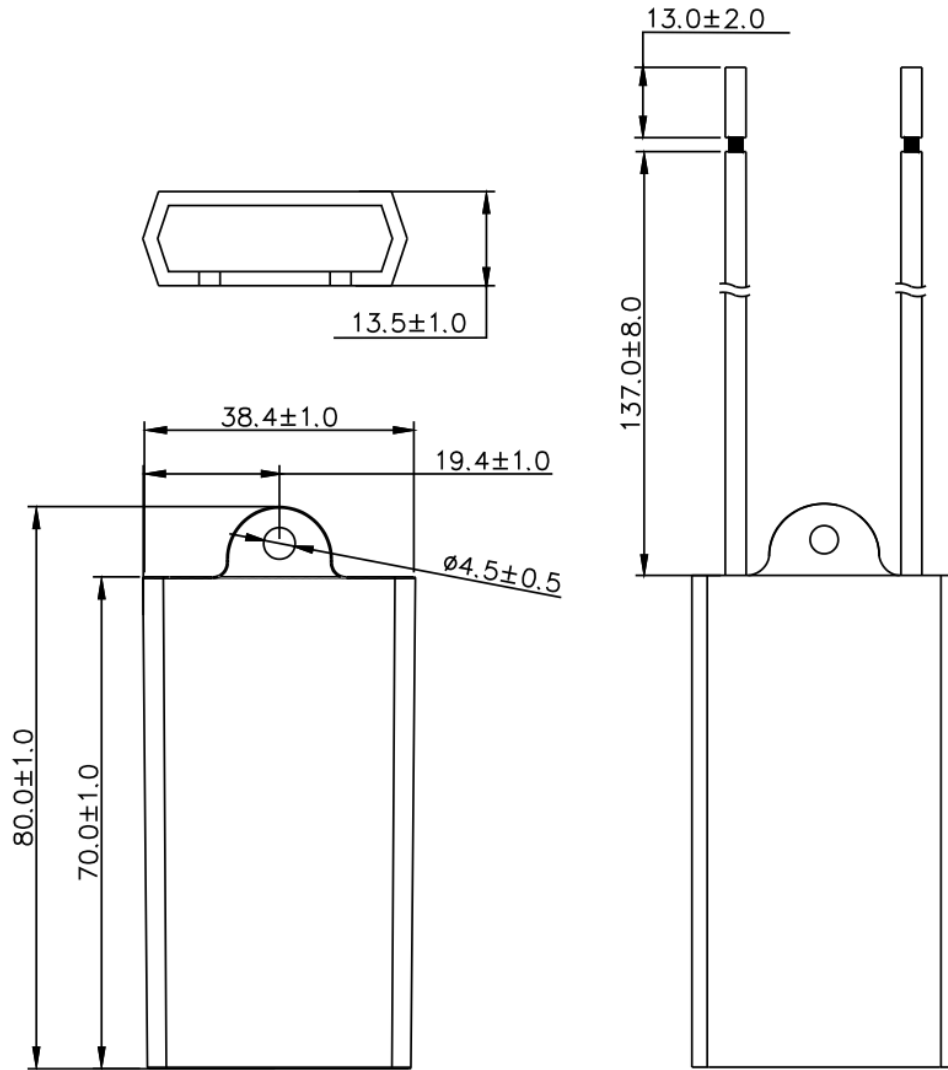

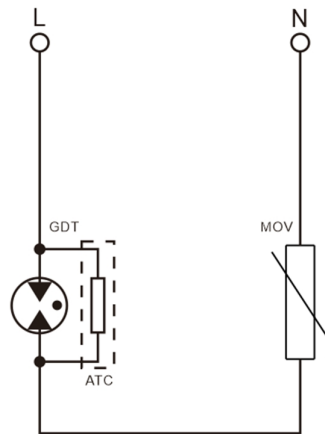

3.4 电路图 Circuit Diagram



注：ATC 为辅助触发电路。

Note: ATC is the auxiliary trigger circuit.

4. 安规认证 Agency Approvals

认证标志 Agency	标准 Standards	认证号 File No.	类别 Category
	EN 61643-11: 2012	UK220909093	Type 2+ Type 3-
	UL1449	E508408	Type 5

5. 环保 Environment

环保 Environment	指令号 Order No.	指令 Order
RoHS	2015/863/EU	满足 RoHS 指令 Meet the RoHS

6. 技术参数 Specifications

技术特性 Technical Feature	技术参数 Technical Parameters	执行标准 Reference Standards
工作温度 Operational Temperature Range	(-40 -85)°C	GB/T 10193 IEC 61051
极限存储温度及湿度 (24 小时) Storage Temperature and Humidity Range (24 hours)	(-40 -85)°C ≤95%RH	IEC 60068-2-1 IEC 60068-2-2
最大持续工作电压 Max. Continuous Operating Voltage (U _c)	277Vac	IEC61643-11
标称放电电流 Nominal Discharge Current(I _n) (8/20 μs)	5kA	IEC61643-11
最大放电电流 Maximum Discharge Current(I _{max})(8/20 μs)	10kA	IEC61643-11
开路电压 Open Circuit Voltage (U _{oc})	10kV	IEC61643-11
最大放电电压 Maximum Discharge Voltage (V _{max})	20kV	/
电压保护水平 Voltage Protection Level (U _P)	1100V	IEC61643-11
保护模式 Modes of Protection	L-N	IEC61643-11
防护等级 Degrees of Protection Provided by Enclosure	IP67	IEC60529
重量 Weight(PCS)	≈0.058 kg	/
海拔 Altitude	≤2000 m	EN 61643-11

7. 检验方法和标准 Inspection Method & Standards

7.1 常规检验项目 General Test Items

序号 No.	项目 Items	检验工具 Inspection Tools	检验要求 Inspection Requirement	参考标准 Reference Standards
1	外观 Appearance	目视 Visual check	外壳无穿孔、无飞边、标示清晰。 The case without perforation and fins, the mark is clear.	企业标准 Enterprise Standard
2	尺寸 Dimension	游标卡尺 vernier caliper	用游标卡尺测量产品尺寸，尺寸范围 3.3。 Use the Vernier caliper to measure the product size, and the size range please reference to the table 3.3.	企业标准 Enterprise Standard

7.2 电压保护等级测试 Voltage Protect Rating Test

参考标准：IEC61643-11-2011 章节 8.3.3.1

Reference Standard: IEC61643.11-2011 Section 8.3.3.1

测试方法：

在试品的棕色线-蓝色线间施加 0.1In、0.2 In、0.5 In、1.0 In 的 8/20us 冲击电流，正负各一次，记录测量波形。

Test Method:

Apply 8/20us impulse current of 0.1In, 0.2 In, 0.5 In, 1.0 In between Brown line-Blue line of the test sample, positive and negative once, and record the measurement waveform.

判定标准：

- 1) 电压和电流波形图及目测检查应没有击穿或闪络的迹象。
- 2) 试验过程中应没有发生可见的损坏。试验后，检查发现的细小的凹痕或裂缝如不影响防直接接接触，则可忽略，除非无法保持 SPD 的防护等级（IP 代码）。试验后，试品上不应有燃烧的痕迹。
- 3) 对防护等级大于或等于 IP20 的 SPD，应使用标准试指施加一个 5N 的力（见 IEC60529）不应触及带电部件，除了 SPD 按正常使用安装后再试验前已可触及的带电部分外。
- 4) 不应有对金属屏栅的闪络，试验过程中连接屏栅的 6AgL/gG 熔断器也不应动作。

Pass criteria:

- 1) Voltage and current records and visual inspection shall show no indication of puncture or flashover.
- 2) No visible damage shall occur during the test. After the test, small indents and cracks not impairing the protection against direct contact are disregarded during this check, unless the degree of protection (IP-code) given for the SPD is no longer provided. There shall be no visual evidence of burning of the sample after the test.
- 3) SPDs with an IP degree equal to, or greater than, IP20 shall not have live parts accessible with the standardized test finger applied with a force of 5 N (see IEC 60529), except the live parts which were already accessible before the test when the SPD is fitted as in normal use.
- 4) There should be no flashover to the metal grid, and the 6AgL/gG fuse connected to the grid should not operate during the test.

7.3 标称放电电流试验 Nominal Discharge Current Test

参考标准: IEC61643-11-2011 章节 8.3.4.3

Reference Standard: IEC61643.11-2011 Section 8.3.4.3

测试方法:

- 1) 对试品棕色线-蓝色线施加 15 次 8/20 正极性的冲击电流, 分成 3 组, 每组 5 次冲击。每次冲击与电源频率同步, 同步角以 $30^{\circ}\pm 5^{\circ}$ 的间隔逐级增加, 每次冲击记录电流波形。
- 2) 每次冲击的同时施加 U_c , 两次冲击之间的间隔时间为 50-60s。
- 3) 两组之间的间隔时间为 30min-35min。
- 4) 15 次冲击结束后, 保持 U_c 时间不少于 15 分钟。

Test Method:

- 1) Apply an impulse current of 8/20 positive polarity to the test samples Brown line-Blue line 15 times, and divide them into 3 groups with 5 impulses in each group. Each shock is synchronized with the power frequency, the synchronization angle increases step by step at intervals of $30^{\circ}\pm 5^{\circ}$, and the current waveform is recorded for each shock.
- 2) Apply U_c at the same time as each impact, The interval between two shocks is 50-60s.
- 3) The interval between two groups is 30min-35min.
- 4) Impact 15 shocks, keep U_c for no less than 15 minutes.

判定标准:

- 1) 产品应达到热稳定。在施加 U_c 电压的最后 15min, 如果电流 I_c 的阻性分量峰值或功耗呈现出下降的趋势或没有升高, 则认为 SPD 是热稳定的。如果试验本身是加电 U_c 进行的, 则不间断地继续保持加电 15min, 或在 30s 内重新加电。
- 2) 电压和电流波形图及目测检查应没有击穿或闪络的迹象。
- 3) 试验过程中无发生可见的损坏。
- 4) 试验后所测量的限制电压应小于或等于 U_p 。
- 5) 试验后, 不得有过高的泄漏电流。SPD 根据制造商的说明书按正常使用连接到参考试验电压 U_{REF} 的电源, 测量流过每个端子的电流, 电流的阻性分量不得超过 1mA, 或者电流增加不得超过在相关试验初始时测量结果的 20%。
- 6) 试验时, 制造商规定的外部脱离器不得动作, 试验后, 该脱离器处在正常工作状态。
- 7) 不得有对人员或者设备产生的爆炸或其他危险。

Pass Criteria:

- 1) Thermal stability shall be achieved. The SPD is considered to be thermally stable if the crest of the resistive component of the current flowing into the SPD or the power dissipation shows either a decreasing tendency or does not increase during 15 min of U_c voltage application immediately after the application of U_c . If the test itself is performed with the SPD energized at U_c , then U_c either remains applied for these 15 min without interruption or is reapplied within less than 30 s.
- 2) Voltage and current records and visual inspection shall show no indication of puncture or flashover.
- 3) No visible damage shall occur during the test.
- 4) Values for measured limiting voltage after the test shall be below or equal to U_p .
- 5) No excessive leakage currents shall occur after the test; The SPD shall be connected as for normal use according to the manufacturer's instructions to a power supply at the reference test

voltage (U_{REF}). The current that flows through each terminal is measured. Its resistive component (measured at the crest of the sine wave) shall not exceed a value of 1 mA, or the current shall not have changed by more than 20 % compared to the initial value determined at the beginning of the relevant test sequence.

- 6) External disconnectors as specified by the manufacturer shall not operate during the test and shall be in working order after the test.
- 7) There shall be no explosion or other hazard to either personnel or the facility.

8. 安全预防措施 Safety Precautions

8.1 安装前阅读并理解所有说明。

Read and understand all instructions before installation.

8.2 持续施加在产品上的电压不应超过其最大连续工作电压 U_c 。

The voltage continuously applied to the product should not exceed its maximum continuous working voltage U_c .

8.3 装配时不要用丙酮等溶剂清洗本产品，以免破坏本产品的封装层。

Avoiding to destroy enclosure, solvent such as acetone is forbidden for cleaning products when assembly.

8.4 装配时应避免出现如敲击等作业方式，避免造成本产品出现机械损伤。

Avoiding making mechanical damage on products, improper operation such as knocking when assembly is not allowed.

8.5 应用本产品的设备必须有可靠的接地线与大地相连，地线长度应小于 0.5 米。

Equipment on the use of the products must have reliable grounding to the earth, the length of the grounding wire less than 0.5 m.

8.6 未遵守操作说明可能导致电气系统或相关设备损坏。

If you do not obey the instructions, the electric system or associated equipment may be breakdown.

8.7 安装位置：室内/室外

Installation location: Indoors/Outdoors.

8.8 系统电压波动范围小于 10%。

Fluctuation range of system voltage shall be less than 10%.

8.9 安装方式 Mounting Method
SPD 外置引线与被保护设备并联连接。

The SPD external leads are connected in parallel with the protected device.

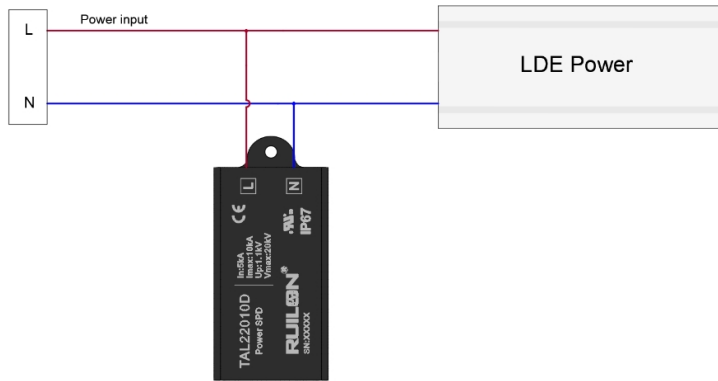

9. 标示及包装 Marks and Package

9.1 产品本体标示 Marking on Product



9.2 包装 Packaging

包装方式与要求 Packaging Method and Requirement		
包装尺寸(mm) Dimensions	吸塑盘 Vacuum forming plate 385*257*25	外箱 Carton 395*267*285
数量 (PCS) Quantity	10	150
净重(kg) Net Weight	≈0.58	≈8.7
毛重(kg) Gross Weight	≈0.65	≈10.14
备注: Remark:		

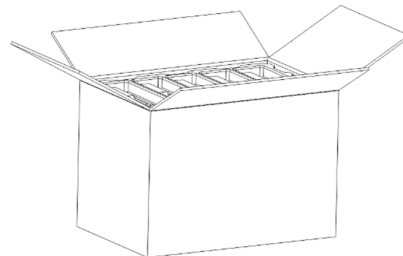
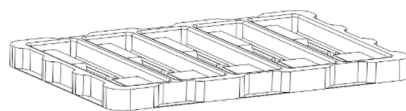

10. 产品批号&追溯号识别 Lot No. & Tracking No. System

大包装追溯号:

Tracking No. on the Outer Package:

Product code(产品代码)	10.20.00.0020
Lot No(批次)	生产批次 Production batch
Product number(产品型号)	TAL22010D
Quantity (数量)	150



11. 储存条件和有效日期 Storage Conditions and Effective Date

- a) 推荐长期存储条件: 存储温度: (-10 - 40) °C, 存储湿度: ≤75%RH。
Recommend Long-term Storage Condition: Storage Temperature: (-10 - 40) °C, Storage Humidity ≤75%RH.
- b) 不要将本产品存放在有腐蚀性气体或阳光直接照射的环境中。
Do not store the products in the environment that with corrosive gas or under direct sunlight.
- c) 存储期限: 2 年。
Storage Period: 2 years.

12. 有效性 Validity

12.1 修订协议 Agreement of Revision

本规格书的内容若有不充分或需要修订时, 得由两公司协议后再行修订。

If the content of the specifications is inadequate or need revising, it will be revised after agreement by both parties.

12.2 有效性 Validity

本规格书提出后, 于贵公司承认期间, 可暂时使用, 若经过 1 个月后贵公司无异议或未签回规格书时, 则视同有效文件运用。

The specifications can be used temporarily during the period of approval. If you have no any objection or not return one hardcopy to us within 1 month, the specifications will be operated as a valid document.

-以下无正文 END-