

深圳市瑞隆源电子有限公司 Shenzhen RUILONGYUAN Electronics Co.,Ltd.			
产品名称 Product name	电涌保护器 Surge Protective Device	产品型号 Product type	TA40-275P3N
文件编号 File serial number	SP-SPD-114	产品编码 Product code	10.20.22.2756
类别 Classification	<input type="checkbox"/> 参考阶段 Reference <input type="checkbox"/> 样品阶段 Sample <input type="checkbox"/> 正式承认 Qualified <input checked="" type="checkbox"/> 工程变更 Changed		

# TA40-275P3N

## 电涌保护器 技术规格书

Surge Protective Device Technical Specification

拟制: Prepared by	Lucy	日期: Date	2024.02.22
审核: Reviewed by	Jim	日期: Date	2024.02.22
批准: Approved by	Robert	日期: Date	2024.02.22

深圳市瑞隆源电子有限公司  
Shenzhen RUILONGYUAN Electronics Co.,Ltd.



## 目录 Catalogue

<b>1.适用范围 Scope</b> .....	4
<b>2.术语 Glossary</b> .....	4
<b>3.结构尺寸 Structure and Dimensions</b> .....	6
3.1 结构图 Structure.....	6
3.2 主要原材料明细 Main Material List .....	6
3.3 产品尺寸 Product Dimensions .....	7
3.4 电路图 Circuit Diagram .....	7
<b>4.安规认证 Agency Approvals</b> .....	7
<b>5.环保 Environment</b> .....	8
<b>6.技术参数 Specifications</b> .....	8
<b>7.检验方法和标准 Inspection Method &amp; Standards</b> .....	9
<b>8.注意事项 Attention</b> .....	11
<b>9.标示及包装 Marks and Package</b> .....	13
<b>10.产品批号&amp;追溯号识别 Lot No. &amp; Tracking No. System</b> .....	14
<b>11.储存条件和有效日期 Storage Conditions and Effective Date</b> .....	14
<b>12.有效性 Validity</b> .....	14
12.1 修订协议 Agreement of Revision .....	14
12.2 有效性 Validity.....	14

## 1. 适用范围 Scope

电涌保护器根据 UL1449 和 IEC/EN61643-11 的相关要求设计，具有安全失效保护，具有失效指示和集中遥信报警干接点等功能；电涌保护器具有良好的高环境适应性，满足重要场所下的高可靠性要求。

Surge protective devices (SPDs) are designed to meet requirements for UL1449 and IEC/EN61643-11. They are Din-rail SPD which featuring with fail-safe protection, visual indicator and remote signal contact etc. It has a good environmental adaptability to important place of high reliability requirements.

## 2. 术语 Glossary

### 2.1 浪涌 Surge

电路中电流、电势或能量的瞬态波；基于本标准，浪涌不包括在几个周期内因升高的工频电压所产生的瞬态过电压（TOV）。

A transient wave of current, potential or power in an electric circuit. For the purposes of this standard, surges do not include temporary over voltages (TOV) consisting of an increase in the power frequency voltage for several cycles.

### 2.2 电涌保护器 Surge Protective Device (SPD)

至少包含一个非线性元件，通过转移或抑制冲击电流来限制冲击电压的设备，且可以重复使用。

A device composed of at least one non-linear component and intended for limiting surge voltages on equipment by diverting or limiting surge current and is capable of repeating these functions as specified.

### 2.3 一端口 SPD one-port SPD

在端子之间没有特定的串联阻抗的 SPD。

SPD having no intended series impedance.

### 2.4 电压开关型 SPD voltage switching type SPD

没有电涌时具有高阻抗，当对电涌电压响应时能突变成低阻抗的 SPD。

SPD that has a high impedance when no surge is present, but can have a sudden change in impedance to a low value in response to a voltage surge.

### 2.5 电压限制型 SPD voltage limiting type SPD

没有电涌时具有高阻抗，但是随着电涌电流和电压的上升，其阻抗将持续地减小的 SPD。

SPD that has a high impedance when no surge is present, but will reduce it continuously with increased surge current and voltage.

### 2.6 状态指示器 Status Indicator

指示 SPD 或者 SPD 一个部件工作状态的设备。

Device that indicates the operational status of an SPD, or a part of an SPD.

### 2.7 1.2/50 $\mu$ s 电压波形 1.2/50 $\mu$ s Voltage Wave

在开路情况下，视在波前时间为 1.2  $\mu$ s，且半峰值时间为 50  $\mu$ s 的冲击电压。

Voltage surge with a virtual front time of 1.2  $\mu$ s and a time to half-value of 50  $\mu$ s delivered across

an open circuit.

- 2.8 8/20  $\mu$ s 电流波形 8/20  $\mu$ s Current Wave  
短路情况下，视在波前时间为 8  $\mu$ s 且半峰值时间为 20  $\mu$ s 的冲击电流。  
Current surge with a virtual front time of 8  $\mu$ s and a time to half-value of 20  $\mu$ s delivered into a short circuit.
- 2.9 最大持续工作电压 Maximum Continuous Operating Voltage (MCOV)  
可连续地施加在 SPD 上的最大交流电压有效值或直流电压。  
Maximum r.m.s. voltage, which may be continuously applied to the SPD's mode of protection.
- 2.10 电压保护水平 Voltage Protection Level (Up)  
由于施加规定陡度的冲击电压和规定幅值及波形的冲击电流而在 SPD 两端之间预期出现的最大电压。  
Maximum voltage to be expected at the SPD terminals due to an impulse stress with defined voltage steepness and an impulse stress with a discharge current with given amplitude and wave shape.
- 2.11 标称放电电流 Nominal Discharge Current (In)  
由厂家给出的，SPD 在经过 15 次 8/20  $\mu$ s 电流波形浪涌冲击后无损坏的电流峰值。  
Peak value of the current, selected by the manufacturer, through the SPD having a current wave shape of 8/20  $\mu$ s where the SPD remains functional after 15 surges.
- 2.12 最大放电电流 Maximum Discharge Current (Imax)  
流过 SPD，具有为 8/20  $\mu$ s 波形电流的峰值，其峰值大小由厂家规定；Imax 等于或大于 In。  
Crest value of a current through the SPD having an 8/20  $\mu$ s wave shape and magnitude according to the manufacturers specification. Imax is equal to or greater than In.
- 2.13 保护模式 Modes of Protection  
在端子间保护保护元器件的电流路径，例如相对相、相对地、相对中线、中线对地。  
An intended current path, between terminals that contains protective components, e.g. line-to-line, line-to-earth, line-to-neutral, neutral-to-earth.
- 2.14 热稳定 Thermal Stability  
在引起 SPD 温度上升的动作负载试验后，在规定的环境温度条件下，给 SPD 施加规定的最大持续工作电压，如果 SPD 的温度能随时间而下降，则认为 SPD 是热稳定的。  
SPD is thermally stable if, after heating up during the operating duty test, its temperature decreases with time while energized at specified maximum continuous operating voltage and at specified ambient temperature conditions.
- 2.15 外壳防护等级（IP 代码）Degrees of Protection Provided by Enclosure (IP code)  
外壳提供的防止触及危险的部件、防止外界固体异物进入和或防止水的进入壳内的防护程度。  
Classification preceded by the symbol IP indicating the extent of protection provided by an enclosure against access to hazardous parts, against ingress of solid foreign objects and

possibly harmful ingress of water.

### 3. 结构尺寸 Structure and Dimensions

#### 3.1 结构图 Structure

产品结构：由三个限压型模块和一个开关型模块组成，每个模块内部都具有热保护功能。

Product Structure: It consists of three voltage-limiting modules and one switching module, and each module has a thermal protection function inside.

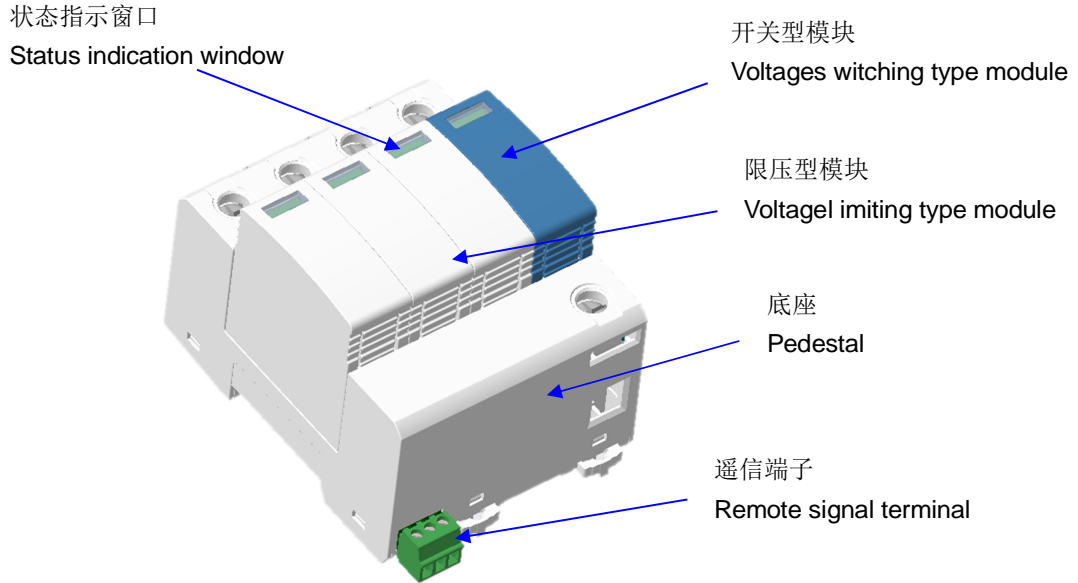

#### 3.2 主要原材料明细 Main Material List

编号 NO.	零件名 Part Name	材质 Materials
1	外壳 Enclosure	塑料 Plastic
2	压敏电阻 Varistor	氧化锌 Zinc Oxide
3	气体放电管 GDT	陶瓷、铜 Ceramics、Cu
4	压线端子 Crimp Terminal	铜 Cu
5	遥信端子 Remote Signal Terminal	塑料、铜 Plastic、Cu

3.3 产品尺寸 Product Dimensions  
单位: mm

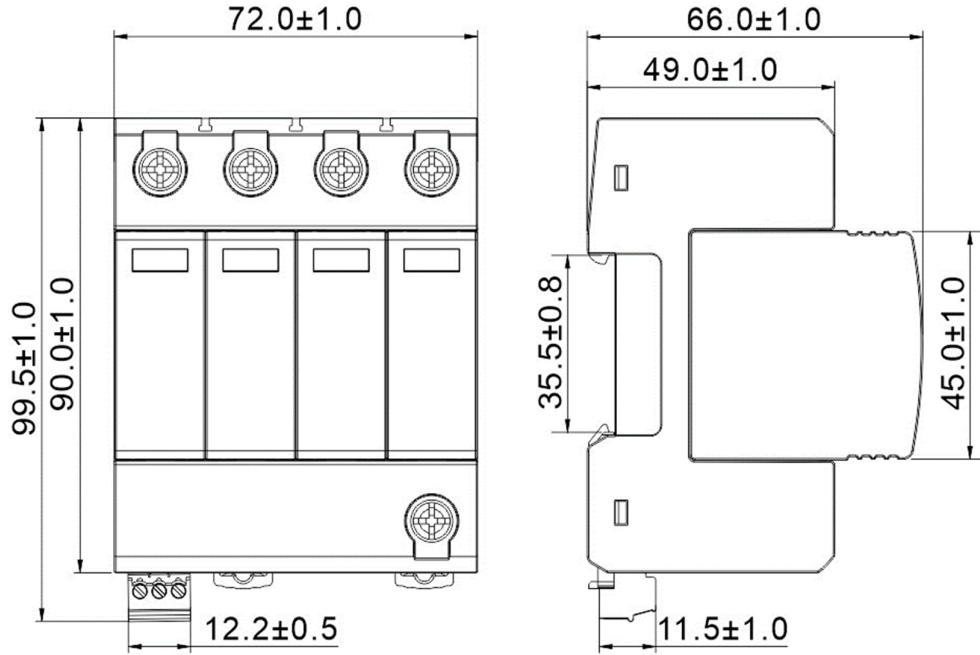

3.4 电路图 Circuit Diagram

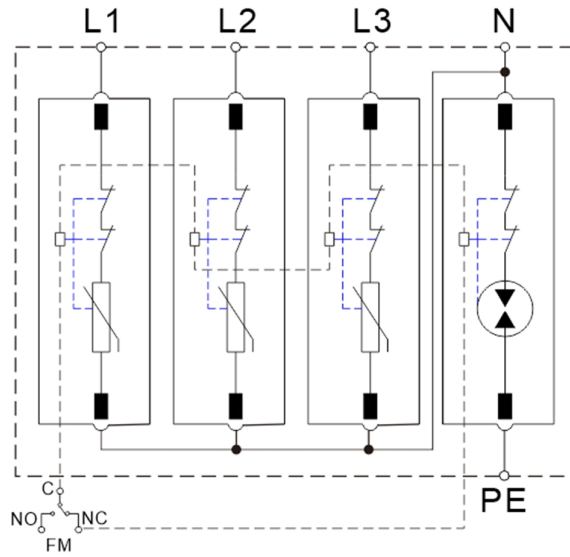

4. 安规认证 Agency Approvals

认证标志 Agency	标准 Standards	认证号 File No.	类别 Category
无			

## 5. 环保 Environment

环保 Environment	指令号 Order No.	指令 Order
RoHS	2015/863/EU	满足 RoHS 指令 Meet the RoHS

## 6. 技术参数 Specifications

技术特性 Technical Feature	技术参数 Technical Parameters	执行标准 Reference Standards
最大持续运行电压 U <sub>c</sub> Maximum Continuous Operating Voltage (U <sub>c</sub> )	L1/L2/L3 - N:275VAC; N - PE: 255VAC	IEC61643-11
标称放电电流 Nominal Discharge Current (8/20 μs) (I <sub>n</sub> )	L1/L2/L3-N:20kA; N-PE:20kA	IEC61643-11
最大放电电流 Maximum Discharge Current (8/20 μs) (I <sub>max</sub> )	L1/L2/L3-N:40kA; N-PE:40kA	IEC61643-11
电压保护水平 Voltage Protection Rating (U <sub>p</sub> )	1.5kV(L-N),1.2kV(N-PE)	IEC61643-11
保护模式 Modes of Protection	L1/L2/L3-N,N-PE	IEC61643-11
外壳防护等级 Degrees of Protection of Enclosure	IP20	IEC60529
接线端子连接铜导线的截面积 The Cross-Sectional Area of The Copper Wire Connected By The Terminal Block	(1.5 to 25) mm <sup>2</sup> (Flexible) 35mm <sup>2</sup> (Rigid)	/
遥信接口最大接线面积 Maximum Wiring Area of Remote Signaling Interface	1.5mm <sup>2</sup>	/
安装方式 Installation	35mm 导轨 DIN rail 35mm	/
本地状态指示 Local Status Indication	正常: 绿色; 失效: 红色 Normal:green; Fault:red	/
遥信告警方式 Remote Signal Alarm Mode	正常: 常闭; 失效: 开路 Normal:Normal Close; Fault: Normal open	/
遥信端子标识 Remote signaling terminal identification	公共点: COM; 常闭: NC; 常开: NO Public Dot: COM; Normally closed: NC; Normally open: NO	/
遥信触点 Remote Indication Contacts	AC: 250V / 0.5A DC: 250V / 0.1A	/
海拔 Altitude	0 ~ 2000m	IEC61643-11
工作温度 Operational Temperature range	(-40 to 85)°C	IEC61643-11



## 7. 检验方法和标准 Inspection Method & Standards

### 7.1 常规检验项目 General Test Items

序号 No.	项目 Items	检验工具 Inspection Tools	检验要求 Inspection Requirement	参考标准 Reference Standards
1	外观 Appearance	目视 Visual check	外壳无穿孔、无飞边、标示清晰。 The case without perforation and fins, the mark is clear.	企业标准 Enterprise Standard
2	尺寸 Dimension	游标卡尺 vernier caliper	用游标卡尺测量产品尺寸，尺寸范围参 3.3。 Use the Vernier caliper to measure the product size, and the size range please reference to the table 3.3.	企业标准 Enterprise Standard
3	状态指示 Status	目视 Visual check	产品正常状态下，指示窗口显示为绿色。 In the normal state of the product, the Indication window is displayed in green.	企业标准 Enterprise Standard

### 7.2 电压保护等级测试 Voltage Protect Rating Test

参考标准：IEC61643-11-2011 章节 8.3.3.1。

Reference Standard: IEC61643.11-2011 Section 8.3.3.1.

测试方法：

- 1) 在试品的 L1-N 间施加 0.1 In、0.2 In、0.5 In、1.0 In 的 8/20μs 冲击电流，正负各一次，记录测量波形。
- 2) 试品 L2-N、L3-N、N-PE 间接上述步骤 1)测试。

Test Method:

- 1) Apply 8/20μs impulse current of 0.1 In, 0.2 In, 0.5 In, 1.0 In between L1-N of the test sample, positive and negative once, and record the measurement waveform.
- 2) Test product L2-N、L3-N、N-PE, following step 1).

判定标准：

- 1) 电压和电流波形图及目测检查应没有击穿或闪络的迹象。
- 2) 试验过程中应没有发生可见的损坏；试验后，检查发现的细小的凹痕或裂缝如不影响防直接接触，则可忽略，除非无法保持 SPD 的防护等级（IP 代码）；试验后，试品上不应有燃烧的痕迹。
- 3) 对防护等级大于或等于 IP20 的 SPD，应使用标准试指施加一个 5N 的力（见 IEC60529）不应触及带电部件，除了 SPD 按正常使用安装后再试验前已可触及的带电部分外。
- 4) 不应有对金属屏栅的闪络，试验过程中连接屏栅的 6AgL/gG 熔断器也不应动作。

Pass criteria:

- 1) Voltage and current records and visual inspection shall show no indication of puncture or flashover.
- 2) No visible damage shall occur during the test. After the test, small indents and cracks not impairing the protection against direct contact are disregarded during this check, unless the degree of protection (IP-code) given for the SPD is no longer provided. There shall be no visual evidence of burning of the sample after the test.
- 3) SPDs with an IP degree equal to, or greater than, IP20 shall not have live parts accessible

with the standardized test finger applied with a force of 5N (see IEC60529), except the live parts which were already accessible before the test when the SPD is fitted as in normal use.

- 4) There should be no flashover to the metal grid, and the 6AgL/gG fuse connected to the grid should not operate during the test.

### 7.3 标称放电电流试验 Nominal Discharge Current Test

参考标准: IEC61643-11-2011 章节 8.3.4.3。

Reference Standard: IEC61643.11-2011 Section 8.3.4.3.

测试方法:

- 1) 对试品 L1-N 施加 15 次 8/20 正极性的冲击电流, 分成 3 组, 每组 5 次冲击; 每次冲击与电源频率同步, 同步角以  $30^{\circ}\pm 5^{\circ}$  的间隔逐级增加, 每次冲击记录电流波形。
- 2) 每次冲击的同时施加  $U_c$ , 两次冲击之间的间隔时间为 50-60s。
- 3) 两组之间的间隔时间为 30min-35min。
- 4) 15 次冲击结束后, 保持  $U_c$  时间不少于 15 分钟。
- 5) 重复上述步骤 1)~ 4) 重复 3 次。
- 6) L2-N、L3-N、N-PE 重复上述步骤。

Test Method:

- 1) Apply an impulse current of 8/20 positive polarity to the test samples L1-N 15 times, and divide them into 3 groups with 5 impulses in each group. Each shock is synchronized with the power frequency, the synchronization angle increases step by step at intervals of  $30^{\circ}\pm 5^{\circ}$ , and the current waveform is recorded for each shock.
- 2) Apply  $U_c$  at the same time as each impact, The interval between two shocks is 50-60s.
- 3) The interval between two groups is 30min-35min.
- 4) Impact 15 shocks, keep  $U_c$  for no less than 15 minutes.
- 5) Steps 1) and 4), above, shall be repeated for a total of 3 cycles.
- 6) Repeat the above test at L2-N, L3-N, N-PE.

判定标准:

- 1) 产品应达到热稳定。在施加  $U_c$  电压的最后 15min, 如果电流  $I_c$  的阻性分量峰值或功耗呈现出下降的趋势或没有升高, 则认为 SPD 是热稳定的; 如果试验本身是加电  $U_c$  进行的, 则不间断地继续保持加电 15min, 或在 30s 内重新加电。
- 2) 电压和电流波形图及目测检查应没有击穿或闪络的迹象。
- 3) 试验过程中无发生可见的损坏。
- 4) 试验后所测量的限制电压应小于或等于  $U_p$ 。
- 5) 试验后, 不得有过高的泄漏电流; SPD 根据制造商的说明书按正常使用连接到参考试验电压  $U_{REF}$  的电源, 测量流过每个端子的电流, 电流的阻性分量不得超过 1mA, 或者电流增加不得超过在相关试验初始时测量结果的 20%。
- 6) 试验时, 制造商规定的外部脱离器不得动作; 试验后, 该脱离器处在正常工作状态。
- 7) 试验时, 制造商规定的内部脱离器不得动作; 试验后, 该脱离器处于正常工作状态。
- 8) 不得有对人员或者设备产生的爆炸或其他危险。

Pass Criteria:

- 1) Thermal stability shall be achieved. The SPD is considered to be thermally stable if the crest of the resistive component of the current flowing into the SPD or the power dissipation shows

either a decreasing tendency or does not increase during 15 min of  $U_c$  voltage application immediately after the application of  $U_c$ . If the test itself is performed with the SPD energized at  $U_c$ , then  $U_c$  either remains applied for these 15 min without interruption or is reapplied within less than 30 s.

- 2) Voltage and current records and visual inspection shall show no indication of puncture or flashover.
- 3) No visible damage shall occur during the test.
- 4) Values for measured limiting voltage after the test shall be below or equal to  $U_P$ .
- 5) No excessive leakage currents shall occur after the test; The SPD shall be connected as for normal use according to the manufacturer's instructions to a power supply at the reference test voltage ( $U_{REF}$ ). The current that flows through each terminal is measured. Its resistive component (measured at the crest of the sine wave) shall not exceed a value of 1 mA, or the current shall not have changed by more than 20% compared to the initial value determined at the beginning of the relevant test sequence.
- 6) External disconnectors as specified by the manufacturer shall not operate during the test and shall be in working order after the test.
- 7) Internal disconnectors as specified by the manufacturer shall not operate during the test and shall be in working order after the test.
- 8) There shall be no explosion or other hazard to either personnel or the facility.

## 8. 注意事项 Attention

- 8.1 安装前阅读并理解所有说明。  
Read and understand all instructions before installation.
- 8.2 安装位置：室内。  
Installation location: Indoors.
- 8.3 持续施加在产品上的电压不应超过其最大连续工作电压  $U_c$ 。  
The voltage continuously applied to the product should not exceed its maximum continuous working voltage  $U_c$ .
- 8.4 通电情况下请勿直接接触本体或引脚，防止触电。  
Do not touch the product body or pins directly when power is on, to avoid electric shock.
- 8.5 仅专业电气人员可进行相关安装和调试；必须遵守相关国家的法规。  
Installation and startup may only be carried out by qualified personnel. The relevant country-specific regulations must be observed.
- 8.6 安装前请务必检查设备是否有外部破损；如果设备有缺陷，则不得使用。  
Check the device for external damage before installation. If the device is defective, it must not be used.
- 8.7 注意触电危险。请在安装使用前断开电源。  
Pay attention to risk of electric shock. Please cut off all electrical power before installation or

service.

- 8.8 连接至电涌保护器（SPD）的输出电缆应尽可能短，避免形成回路。  
Lay the output cables to the surge protective devices (SPDs) as short as possible, without loops.
- 8.9 请在电涌保护器前端安装合适的后备保护装置。  
Please install proper backup protection devices in front of SPD.
- 8.10 安装过程和安装后不宜对电涌保护器本体施加机械应力。  
Do not apply mechanical stress to the SPD body during or after the installation.
- 8.11 线路通电前确保电气连接和安装正确。  
Ensure electrical connections and mountings are correct before energizing the circuit.
- 8.12 如果热保护装置断开，指示窗口将由绿色转换为红色。  
If the Thermal-Links break, the Indication window will be converted from green to red.
- 8.13 每年在雷雨季节的前后根据说明检查 SPD 的状态。  
Check SPD status according to instructions before and after the thunderstorm season each year.
- 8.14 如果出现故障状态指示，则表示 SPD 损坏；请用相同型号的 SPD 替换。  
If the indicator of failure state appears, the SPD is damaged. Replace the SPD with same type.
- 8.15 产品出厂前均经过严格的检验和质量控制，如发现产品异常，请及时与本公司联系。  
SPD's quality is well controlled and strictly inspected before delivery. If non-functional ones are found during operation, please contact us early enough.

8.16 接线示意图 Wiring Diagram

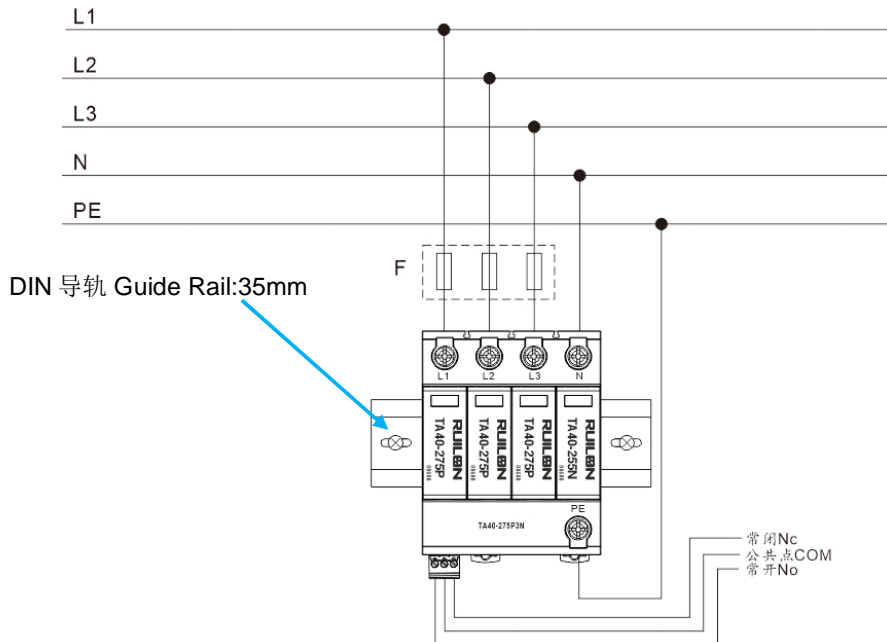

## 9. 标示及包装 Marks and Package

### 9.1 产品本体标识 Marking on Product

顶部标识 Top marking

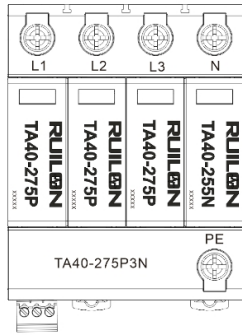

TA40-275P 标识 Marking

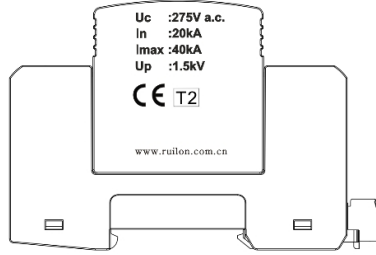

TA40-255N 标识 Marking

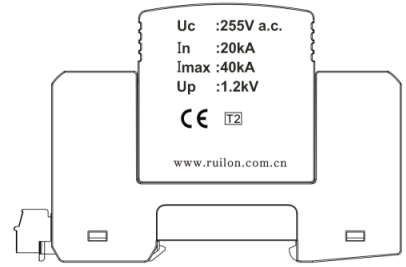

通信标识 Communication marking

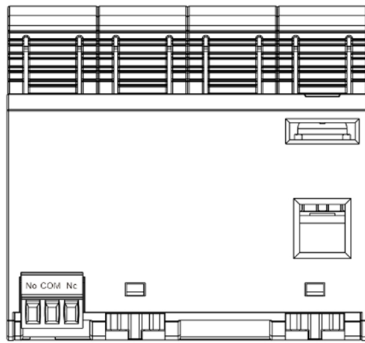

### 9.2 包装 Packaging

#### 包装方式与要求

#### Packaging Method and Requirement

包装尺寸(mm) Dimensions	内盒 Inner Box	外箱 Carton
	96*76*70	300*400*230
数量 (PCS) Quantity	1	45
净重(kg) Net Weight	≈0.361	≈16.245
毛重(kg) Gross Weight	≈0.3784	≈17.58

备注:

Remark:

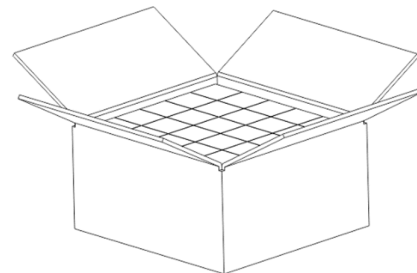
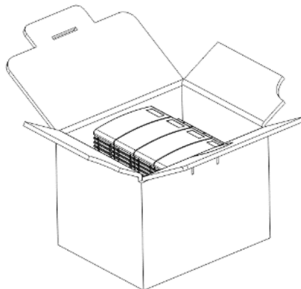

**10. 产品批号&追溯号识别 Lot No. & Tracking No. System**

10.1 产品批号识别 Lot No. System

小包装追溯号:  
Tracking No. on the Inner Packing:

Part No (产品代码)	10.20.22.2756
Lot No (批次)	生产批次 Production batch
Product code (产品型号)	TA40-275P3N
Quantity (数量)	1



10.2 产品追溯号识别 Tracking No. System

大包装追溯号:  
Tracking No. on the Outer Package:

Part No (产品代码)	10.20.22.2756
Lot No (批次)	生产批次 Production batch
Product code (产品型号)	TA40-275P3N
Quantity (数量)	45



**11. 储存条件和有效日期 Storage Conditions and Effective Date**

- a) 推荐长期存储条件: 存储温度: (-10 - 40) °C, 存储湿度: ≤75%RH。  
Recommend Long-term Storage Condition: Storage Temperature: (-10 - 40) °C, Storage Humidity ≤75%RH.
- b) 不要将本产品存放在有腐蚀性气体或阳光直接照射的环境中。  
Do not store the products in the environment that with corrosive gas or under direct sunlight.
- c) 存储期限: 2年。  
Storage Period: 2 years.

**12. 有效性 Validity**

12.1 修订协议 Agreement of Revision

本规格书的内容若有不充分或需要修订时, 得由两公司协议后再行修订。  
If the content of the specifications is inadequate or need revising, it will be revised after agreement by both parties.

12.2 有效性 Validity

本规格书提出后, 于贵公司承认期间, 可暂时使用, 若经过 1 个月后贵公司无异议或未签回规格书时, 则视同有效文件运用。  
The specifications can be used temporarily during the period of approval. If you have no any objection or not return one hardcopy to us within 1 month, the specifications will be operated as a valid document.

-以下无正文 END-