

P2305L

S-P2305L

30V P-Channel Enhancement-Mode MOSFET

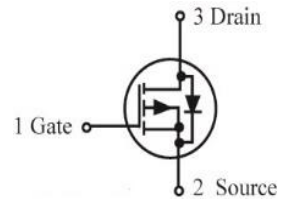
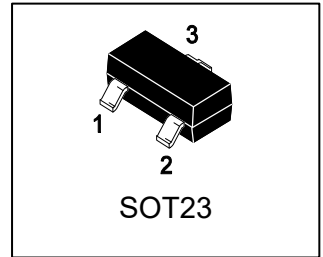

1. FEATURES

- VDS = -30V
- RDS(ON), Vgs@-10V, Ids@-4.2A = 70mΩ
- RDS(ON), Vgs@-4.5V, Ids@-4.0A = 85mΩ
- RDS(ON), Vgs@-2.5V, Ids@-1.0A = 130mΩ
- We declare that the material of product compliance with RoHS requirements and Halogen Free.
- S- prefix for automotive and other applications requiring unique site and control change requirements; AEC-Q101 qualified and PPAP capable.

2. APPLICATIONS

- Advanced trench process technology
- High density cell design for ultra low on-resistance.

3. DEVICE MARKING AND ORDERING INFORMATION

Device	Marking	Shipping
P2305L	P05	3000/Tape&Reel

4. MAXIMUM RATINGS(Ta = 25°C)

Parameter	Symbol	Limits	Unit
Drain-Source Voltage	VDSS	-30	V
Gate-to-Source Voltage – Continuous	VGS	±12	V
Drain Current			A
– Continuous TA = 25°C	ID	-4.2	
– Pulsed (Note 1)	IDM	-30	

5. THERMAL CHARACTERISTICS

Parameter	Symbol	Limits	Unit
Power Dissipation	PD	0.9	W
Thermal Resistance, Junction-to-Ambient(Note 2)	RθJA	140	°C/W
Junction and Storage temperature	TJ, Tstg	-55~+150	°C

1.Repetitive Rating: Pulse width limited by the maximum junction temperature.

2.1-in² 2oz Cu PCB board.



6. ELECTRICAL CHARACTERISTICS (Ta= 25°C)

Characteristic	Symbol	Min.	Typ.	Max.	Unit	
Static						
Drain–Source Breakdown Voltage (VGS = 0, ID = -250μA)	VBRDSS	-30	-	-	V	
Zero Gate Voltage Drain Current (VGS = 0, VDS = -24 V)	IDSS	-	-	-1	μA	
Gate–Body Leakage Current, Forward (VGS = ±12 V)	IGSS	-	-	±100	nA	
Gate Threshold Voltage (VDS = VGS, ID = -250μA)	VGS(th)	-0.6	-	-1.3	V	
Static Drain–Source On–State Resistance (VGS = -10 V, ID = -4.2 A) (VGS = -4.5 V, ID = -4 A) (VGS = -2.5 V, ID = -1 A)	RDS(on)	-	53 64 86	70 85 130	mΩ	
Dynamic						
Input Capacitance (VGS = 0 V, f = 1.0MHz, VDS= -15 V)	Ciss	-	716	-	pF	
Output Capacitance (VGS = 0 V, f = 1.0MHz, VDS= -15 V)	Coss	-	47.5	-	pF	
Reverse Transfer Capacitance (VGS = 0 V, f = 1.0MHz, VDS= -15 V)	Crss	-	37.4	-	pF	
Total Gate Charge(VGS=-4.5V)	(VDS = -15 V, VGS=-10V, ID =-4.2A)	Qg	-	7.2	-	nC
Total Gate Charge(VGS=-10V)		Qg	-	14.8	-	
Gate to Source Charge		Qgs	-	1.36	-	
Gate to Drain Charge		Qgd	-	1.98	-	
Turn-On Delay Time	(VDS = -15 V, RL=15Ω, VGEN =-10V, RG= 6.2Ω)	td(on)	-	6	-	ns
Rise Time		tr	-	5.4	-	
Turn-Off Delay Time		td(off)	-	125.5	-	
Fall Time		tf	-	27.8	-	
Forward Voltage (VGS = 0 V, ISD = -1 A)	VSD	-	-	-1	V	

3.Pulse Test: Pulse Width ≤300 μs, Duty Cycle ≤2.0%.



7. ELECTRICAL CHARACTERISTICS CURVES

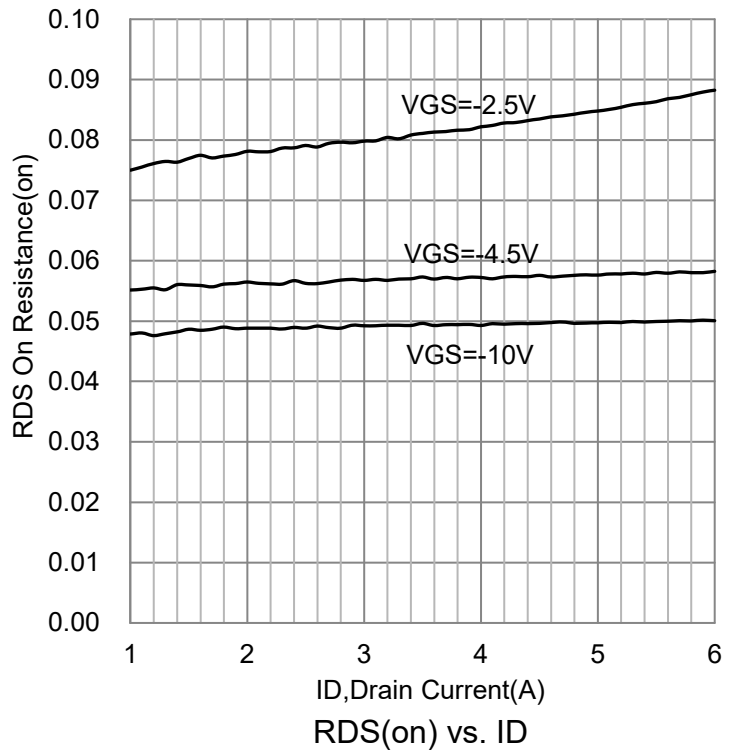
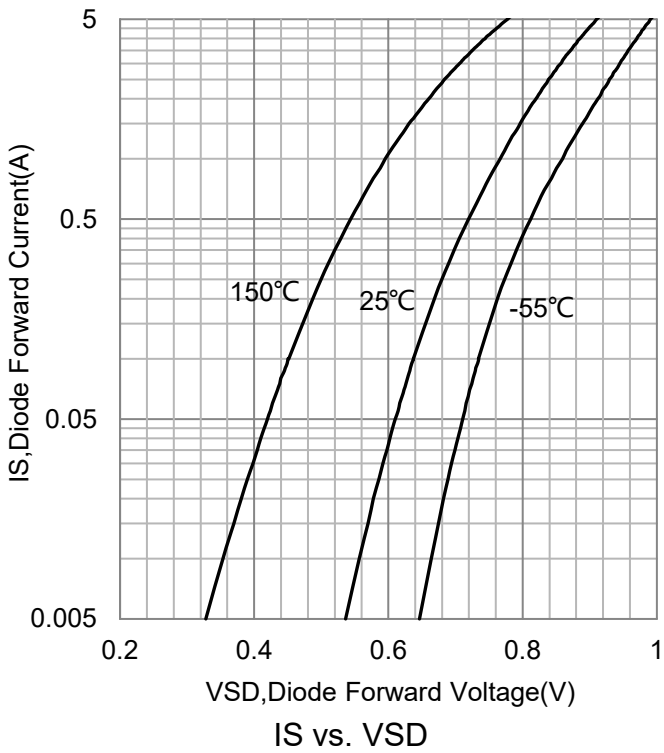
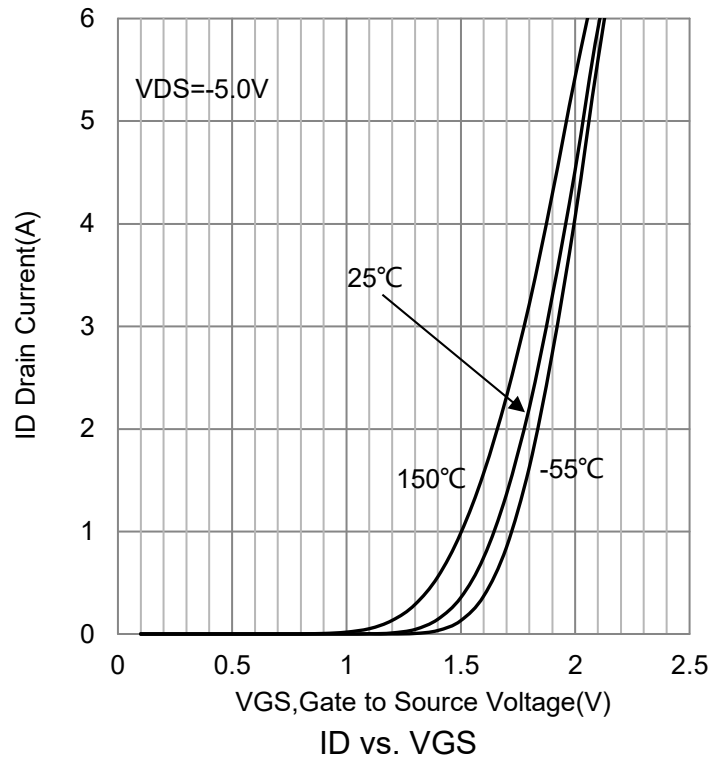
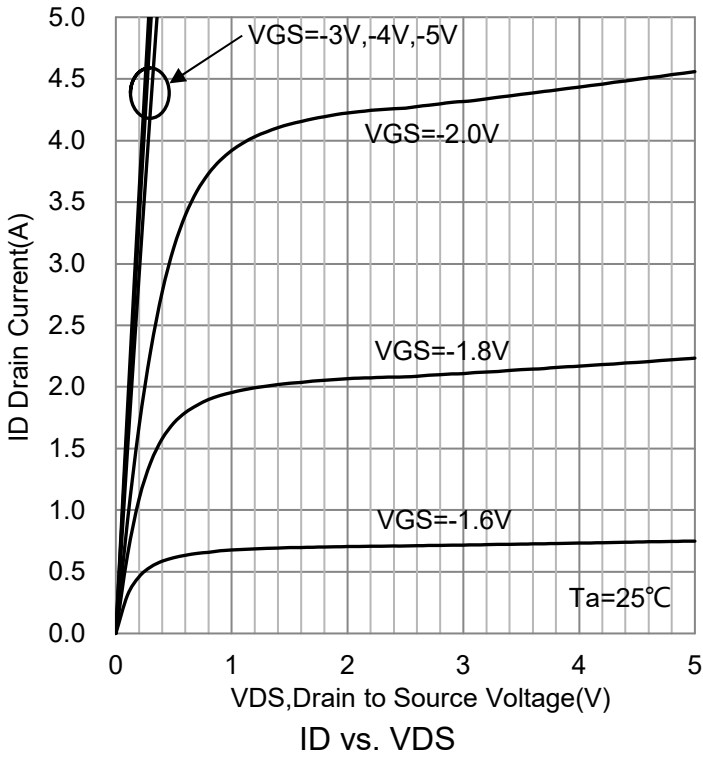

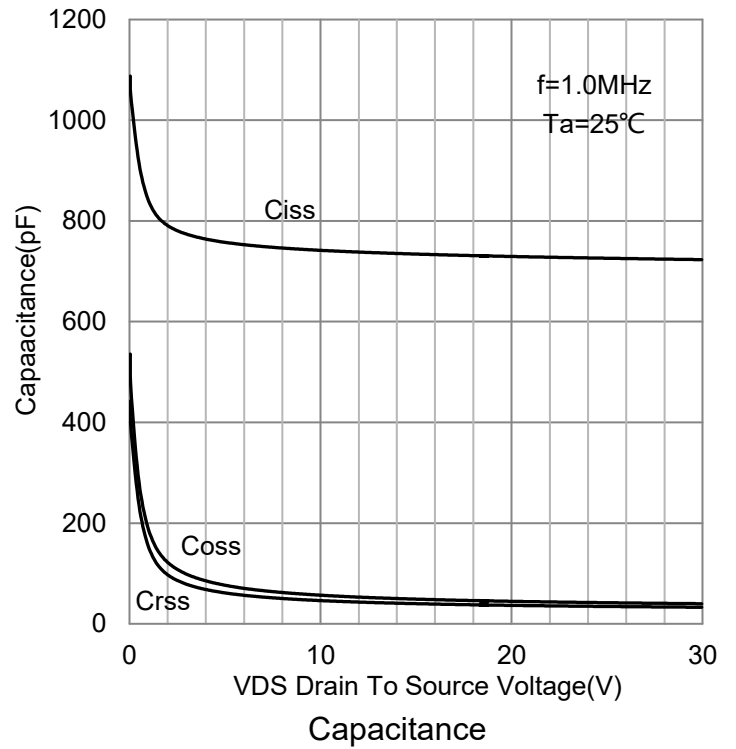
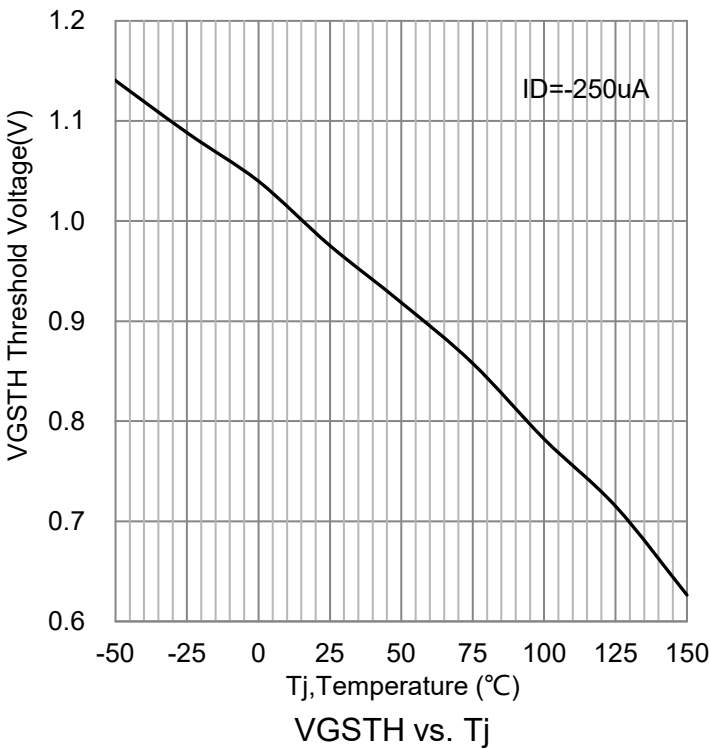
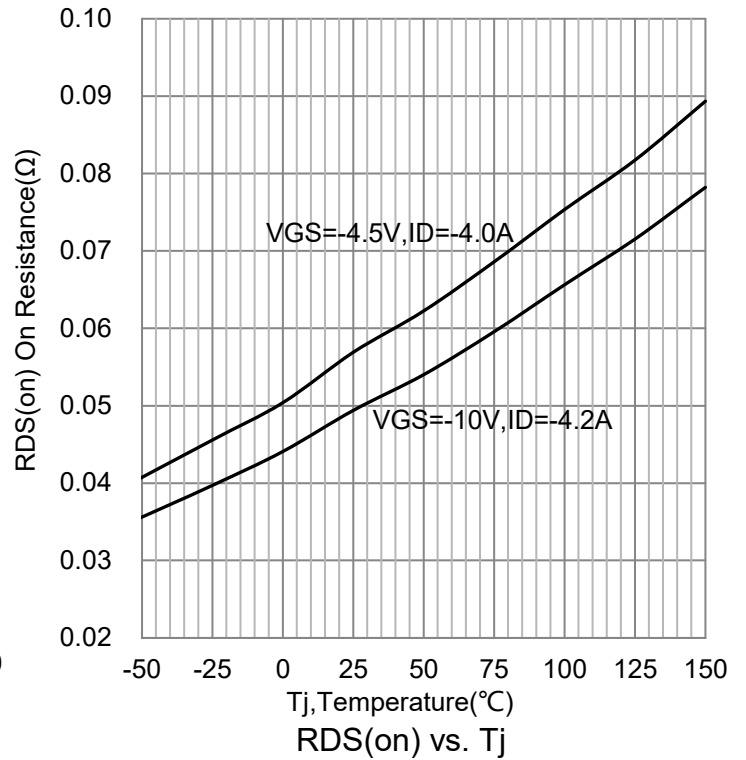
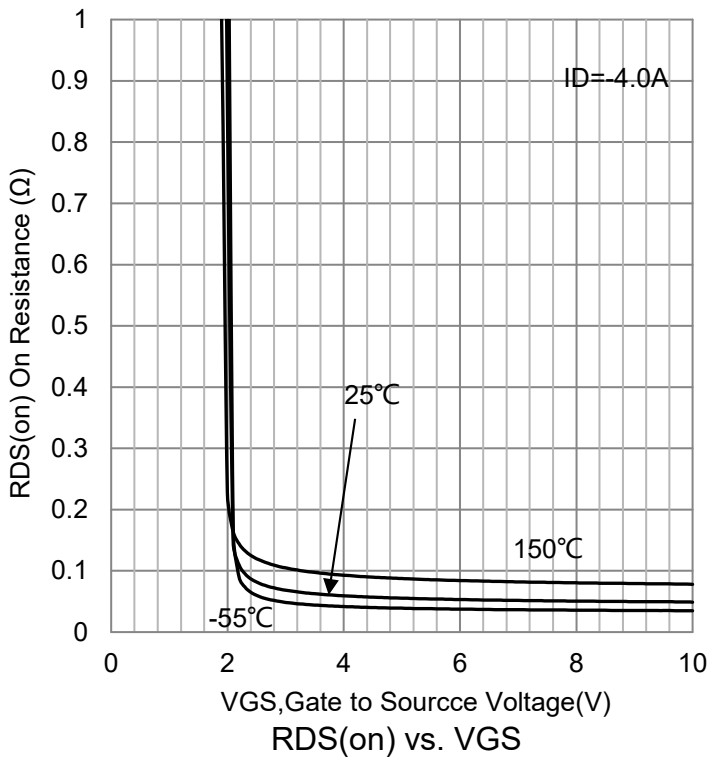
7. ELECTRICAL CHARACTERISTICS CURVES(Con.)

7. ELECTRICAL CHARACTERISTICS CURVES(Con.)

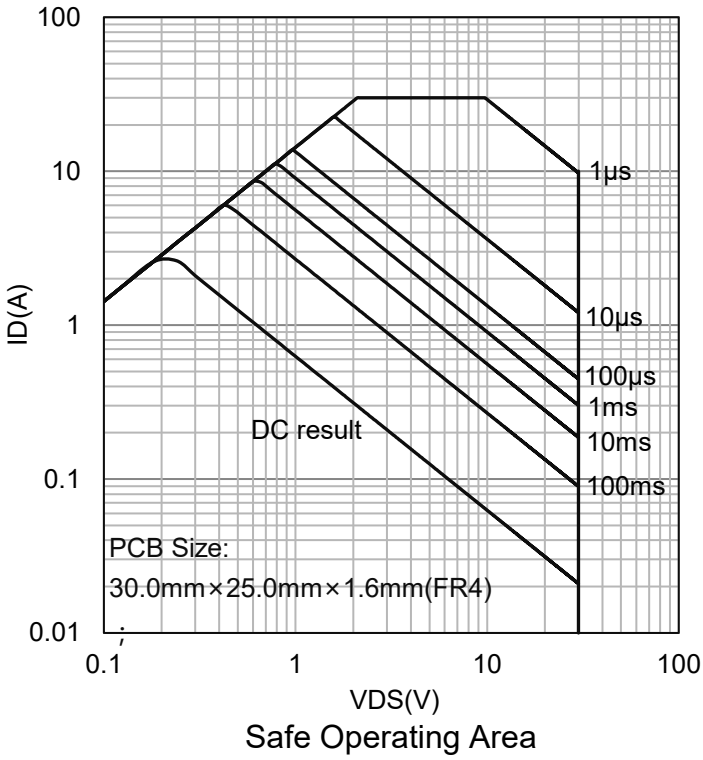

8. OUTLINE AND DIMENSIONS

Notes:

1. DIMENSIONING AND TOLERANCING PER ANSI Y14.5M, 1982.
2. CONTROLLING DIMENSION: MILLIMETERS.
3. MAXIMUM LEAD THICKNESS INCLUDES LEAD FINISH. MINIMUM LEAD THICKNESS IS THE MINIMUM THICKNESS OF BASE MATERIAL.
4. DIMENSIONS D AND E DO NOT INCLUDE MOLD FLASH, PROTRUSIONS OR GATE BURRS.

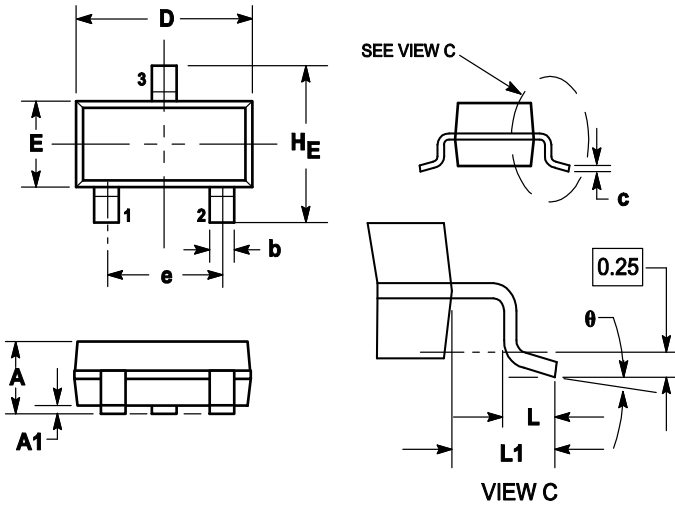

DIM	MILLIMETERS			INCHES		
	MIN	NOM	MAX	MIN	NOM	MAX
A	0.89	1	1.11	0.035	0.04	0.044
A1	0.01	0.06	0.1	0.001	0.002	0.004
b	0.37	0.44	0.5	0.015	0.018	0.02
c	0.09	0.13	0.18	0.003	0.005	0.007
D	2.80	2.9	3.04	0.11	0.114	0.12
E	1.20	1.3	1.4	0.047	0.051	0.055
e	1.78	1.9	2.04	0.07	0.075	0.081
L	0.10	0.2	0.3	0.004	0.008	0.012
L1	0.35	0.54	0.69	0.014	0.021	0.029
HE	2.10	2.4	2.64	0.083	0.094	0.104
θ	0°	---	10°	0°	---	10°

9. SOLDERING FOOTPRINT

