

P2305A

20V P-Channel Enhancement-Mode MOSFET

1. FEATURES

- VDS = -20V
- RDS(ON), VGS@-4.5V, ID@-3.5A = 68mΩ
- RDS(ON), VGS@-2.5V, ID@-3A = 81mΩ
- RDS(ON), VGS@-1.8V, ID@-2A = 118mΩ
- Advanced trench process technology
- High Density Cell Design For Ultra Low On-Resistance
- Fully Characterized Avalanche Voltage and Current
- Improved Shoot-Through FOM
- We declare that the material of product compliance with RoHS requirements and Halogen Free.

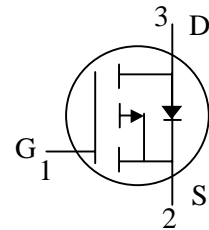
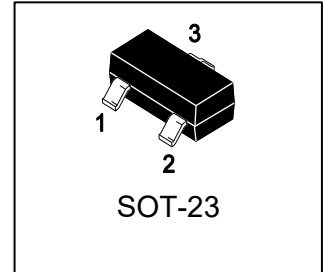

2. DEVICE MARKING AND ORDERING INFORMATION

Device	Marking	Shipping
P2305A	P5A	3000/Tape&Reel

3. MAXIMUM RATINGS(Ta = 25°C)

Parameter	Symbol	Limits	Unit
Drain-Source Voltage	VDSS	-20	V
Gate-to-Source Voltage	VGS	±8	V
Continuous Drain Current	ID	-4	A
Pulsed Drain Current(Note 1)	IDM	-12	A
Power Dissipation(Note 2)	PD	1100	mW
Operating Junction and Storage Temperature Range	TJ,Tstg	-55~+150	°C

1. Repetitive Rating: Pulse width limited by the maximum junction temperature

2.FR-5 = 1.0×0.75×0.062 in.

4. THERMAL CHARACTERISTICS

Parameter	Symbol	Limits	Unit
Thermal Resistance, Junction-to-Ambient	RθJA	110	°C/W



5. ELECTRICAL CHARACTERISTICS (Ta= 25°C)

Characteristic	Symbol	Min.	Typ.	Max.	Unit	
Static						
Drain–Source Breakdown Voltage (VGS = 0, ID = -250μA)	VBRDSS	-20	-	-	V	
Zero Gate Voltage Drain Current (VGS = 0, VDS = -6.4 V)	IDSS	-	-	-1	μA	
Gate–Body Leakage Current (VGS= ± 8V, VDS = 0V)	IGSS	-	-	±100	nA	
Forward Transconductance (VDS = -5V, ID = -3.5A)	gfs	-	8.5	-	S	
Gate Threshold Voltage (VDS = VGS, ID = -250μA)	VGS(th)	-0.45	-	-0.8	V	
Static Drain–Source On–State Resistance (VGS = -4.5 V, ID = -3.5 A) (VGS = -2.5 V, ID = -3 A) (VGS = -1.8 V, ID = -2 A)	RDS(on)	-	47 55 67	68 81 118	mΩ	
On-State Drain Current (VDS ≤ -5 V, VGS ≤ -4.5 V) (VDS ≤ -5 V, VGS ≤ -2.5 V)	ID(on)	-6 -3	-	-	A	
Source-Drain Diode						
Diode Forward Current	IS	-	-1.6	-	A	
Forward Voltage (IS = -1.6A, VGS = 0V)	VSD	-	-	-1.2	V	
Dynamic						
Total Gate Charge (VDS=-10V, VGS=-4.5V, ID=-3.0A)	Qg	-	5.76	-	nC	
Gate-Source Charge (VDS=-10V, VGS=-4.5V, ID=-3.0A)	Qgs	-	0.88	-		
Gate-Drain Charge (VDS=-10V, VGS=-4.5V, ID=-3.0A)	Qgd	-	2.2	-		
Input Capacitance (VGS = 0 V, f = 1.0MHz, VDS= -4 V)	Ciss	-	1245	-	pF	
Output Capacitance (VGS = 0 V, f = 1.0MHz, VDS= -4 V)	Coss	-	375	-	pF	
Reverse Transfer Capacitance (VGS = 0 V, f = 1.0MHz, VDS= -4 V)	Crss	-	210	-	pF	
Switching						
Turn-On Delay Time	(VDD = -4V, RL= 4Ω ID = -1A, VGEN = -4.5V RG = 6Ω)	td(on)	-	13	20	ns
Rise Time		tr	-	25	40	
Turn-Off Delay Time		td(off)	-	55	80	
Fall Time		tf	-	19	35	

3.Pulse Test: Pulse Width ≤300 μs, Duty Cycle ≤2.0%.



6.ELECTRICAL CHARACTERISTICS CURVES

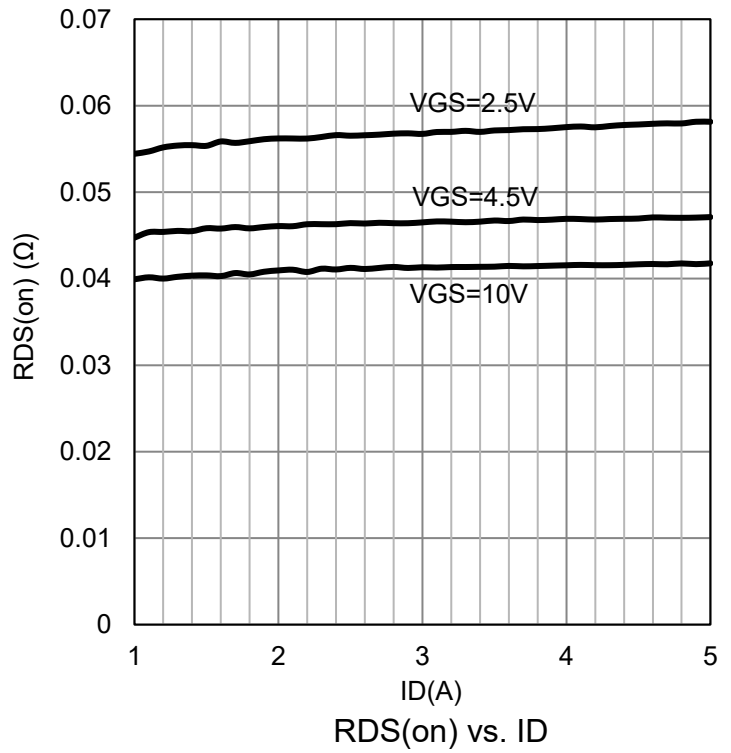
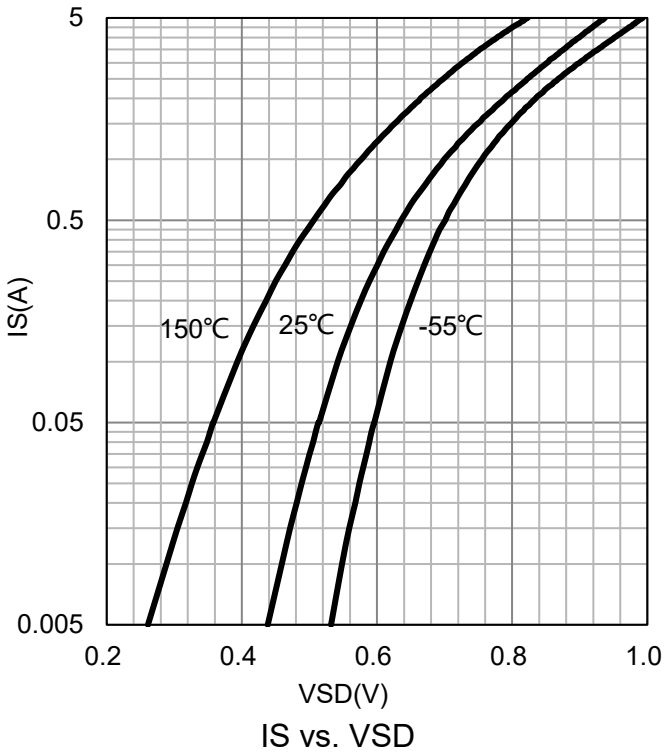
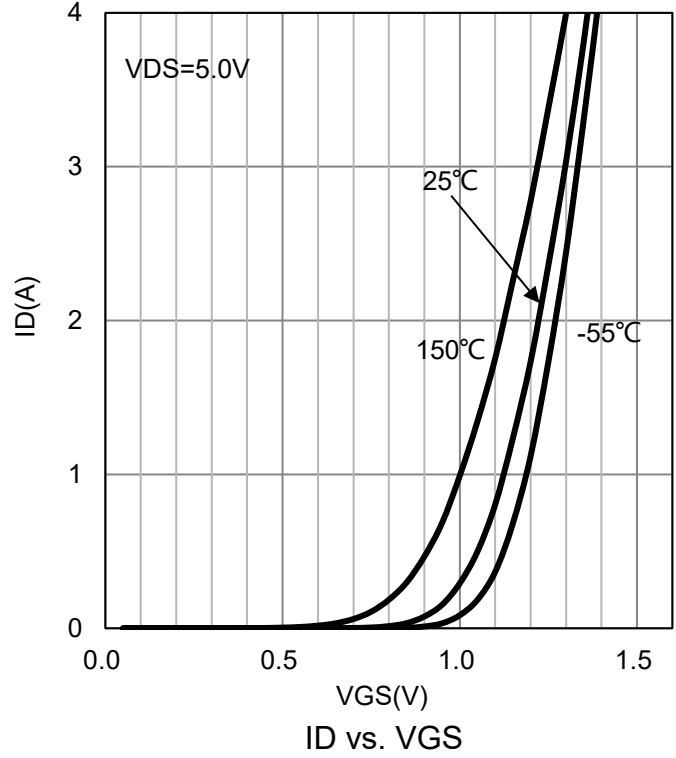
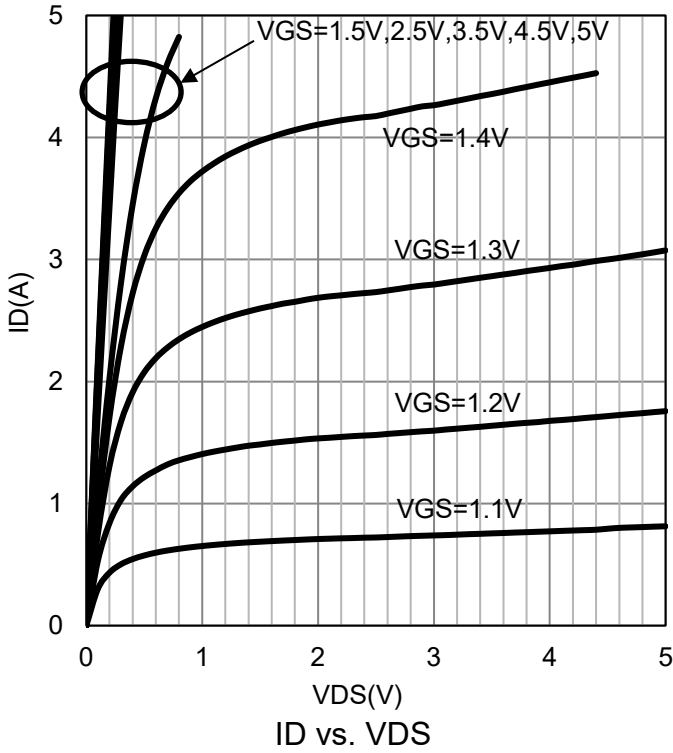

6.ELECTRICAL CHARACTERISTICS CURVES(Con.)

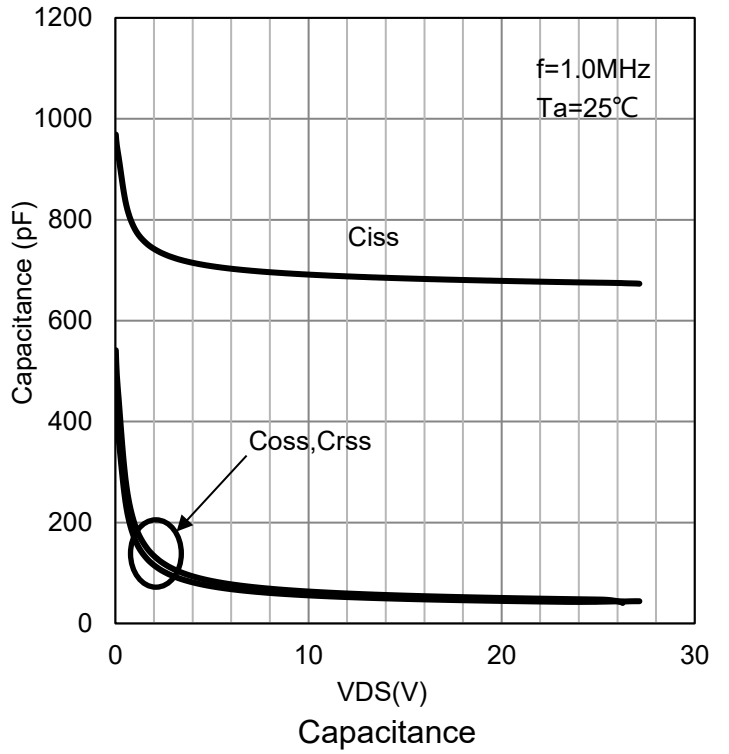
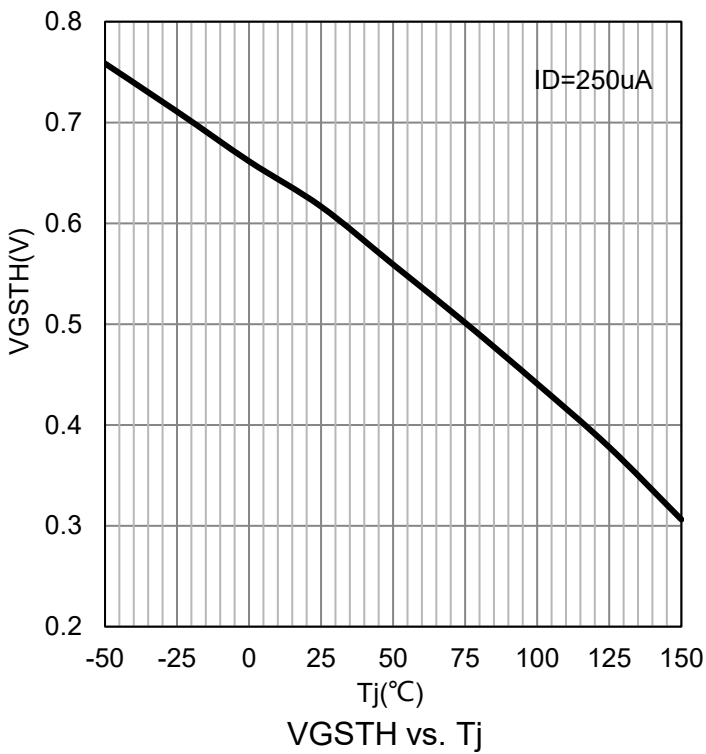
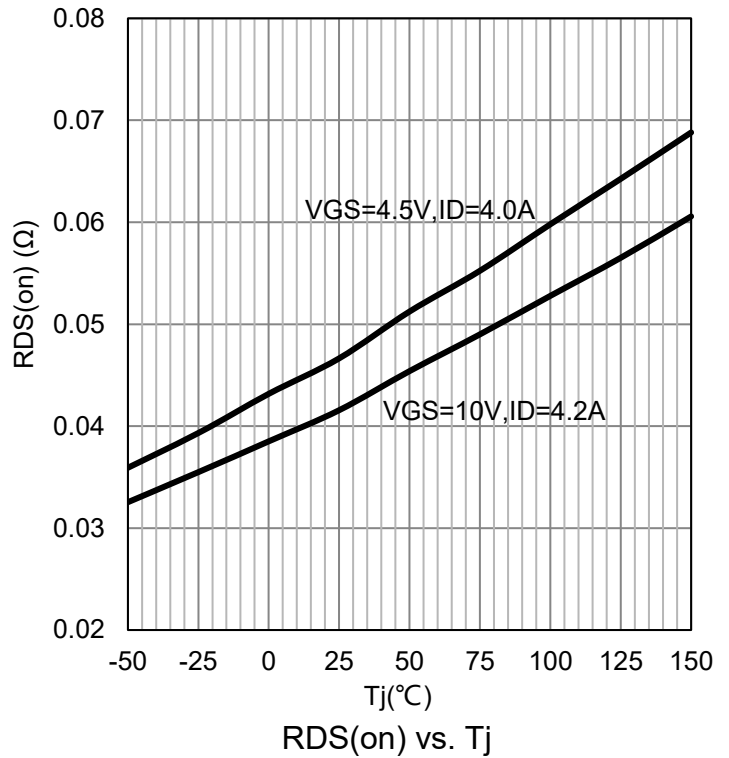
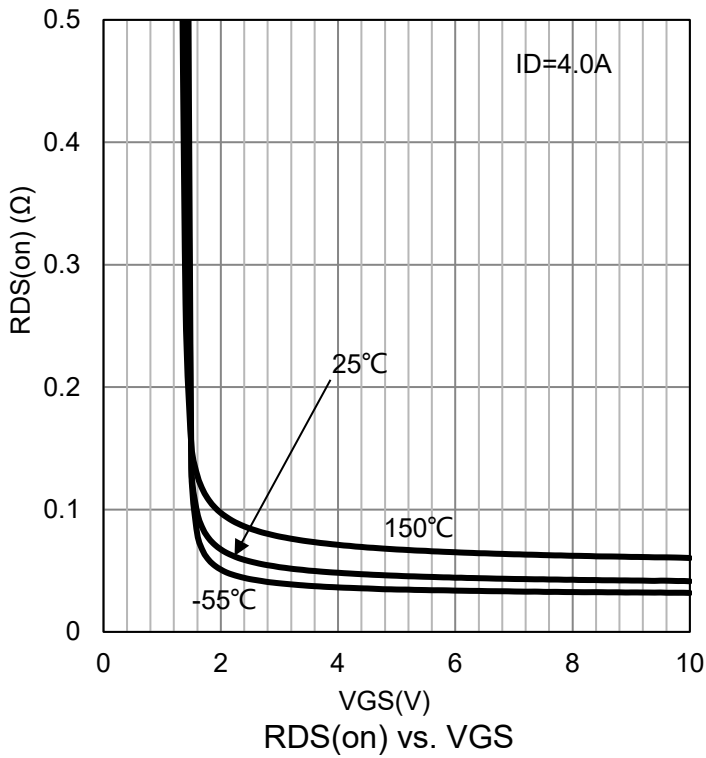

7. OUTLINE AND DIMENSIONS

Notes:

1. DIMENSIONING AND TOLERANCING PER ANSI Y14.5M, 1982.
2. CONTROLLING DIMENSION: MILLIMETERS.
3. MAXIMUM LEAD THICKNESS INCLUDES LEAD FINISH. MINIMUM LEAD THICKNESS IS THE MINIMUM THICKNESS OF BASE MATERIAL.
4. DIMENSIONS D AND E DO NOT INCLUDE MOLD FLASH, PROTRUSIONS OR GATE BURRS.

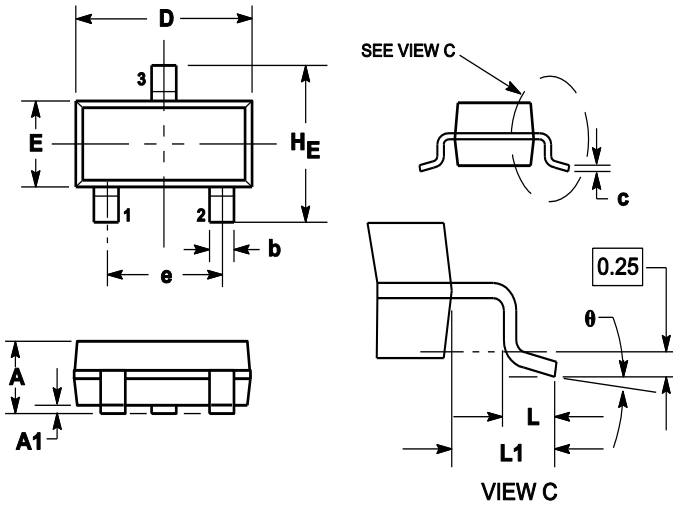

DIM	MILLIMETERS			INCHES		
	MIN	NOM	MAX	MIN	NOM	MAX
A	0.89	1	1.11	0.035	0.04	0.044
A1	0.01	0.06	0.1	0.001	0.002	0.004
b	0.37	0.44	0.5	0.015	0.018	0.02
c	0.09	0.13	0.18	0.003	0.005	0.007
D	2.80	2.9	3.04	0.11	0.114	0.12
E	1.20	1.3	1.4	0.047	0.051	0.055
e	1.78	1.9	2.04	0.07	0.075	0.081
L	0.10	0.2	0.3	0.004	0.008	0.012
L1	0.35	0.54	0.69	0.014	0.021	0.029
HE	2.10	2.4	2.64	0.083	0.094	0.104
theta	0°	---	10°	0°	---	10°

8. SOLDERING FOOTPRINT
