

# P2301CL

## 20V P-Channel Enhancement-Mode MOSFET

### 1. FEATURES

- $V_{DS} = -20V$
- $R_{DS(ON)}, V_{GS@-2.5V}, I_{DS@-2.0A} = 150m\Omega$
- $R_{DS(ON)}, V_{GS@-4.5V}, I_{DS@-2.8A} = 100m\Omega$
- We declare that the material of product compliance with RoHS requirements and Halogen Free.
- S- prefix for automotive and other applications requiring unique site and control change requirements; AEC-Q101 qualified and PPAP capable.
- Advanced trench process technology
- High density cell design for ultra low on-resistance
- Fully characterized avalanche voltage and current improved shoot-through FOM

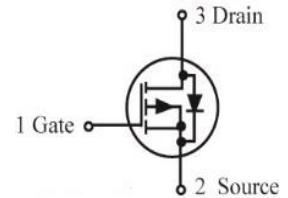
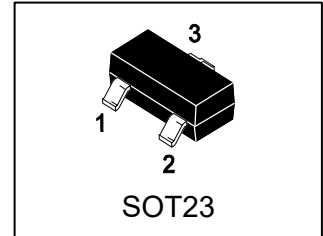

### 2. APPLICATIONS

- Simple drive requirement
- Small package outline
- Surface mount device

### 3. DEVICE MARKING AND ORDERING INFORMATION

Device	Marking	Shipping
P2301CL	01C	3000/Tape&Reel

### 4. MAXIMUM RATINGS( $T_a = 25^\circ C$ )

Parameter	Symbol	Limits	Unit
Drain-Source Voltage	VDSS	-20	V
Gate-to-Source Voltage – Continuous	VGS	$\pm 8$	V
Drain Current			
– Continuous $T_A = 25^\circ C$	ID	-2.3	A
– Pulsed(Note 1)	IDM	-8	

### 5. THERMAL CHARACTERISTICS

Parameter	Symbol	Limits	Unit
Maximum Power Dissipation	PD	0.9	W
Thermal Resistance, Junction-to-Ambient(Note 2)	ROJA	140	$^\circ C/W$
Junction and Storage temperature	$T_J, T_{stg}$	$-55 \sim +150$	$^\circ C$

1. Repetitive Rating: Pulse width limited by the Maximum junction temperature.
2. 1-in<sup>2</sup> 2oz Cu PCB board.



**6. ELECTRICAL CHARACTERISTICS (Ta= 25°C)**
**OFF CHARACTERISTICS**

Characteristic	Symbol	Min.	Typ.	Max.	Unit
Drain–Source Breakdown Voltage (VGS = 0, ID = -250 $\mu$ Adc)	VBRDSS	-20	-	-	Vdc
Zero Gate Voltage Drain Current (VGS = 0, VDS = -9.6 Vdc)	IDSS	-	-	-1	$\mu$ Adc
Gate–Body Leakage Current, Forward (VGS = 8 Vdc)	IGSSF	-	-	100	nAdc
Gate–Body Leakage Current, Reverse (VGS = - 8 Vdc)	IGSSR	-	-	-100	nAdc

**ON CHARACTERISTICS (Note 3)**

Gate Threshold Voltage (VDS = VGS, ID = -250 $\mu$ Adc)	VGS(th)	-0.4	-	-0.9	Vdc
Static Drain–Source On–State Resistance (VGS = -4.5 Vdc, ID = -2.8 Adc) (VGS = -2.5 Vdc, ID = -2 Adc)	RDS(on)	-	72 88	100 150	m
Forward Transconductance (VDS = -5V, ID = -4.0Adc)	gfs	-	6.5	-	S

**DYNAMIC CHARACTERISTICS**

Input Capacitance (VGS = 0 V, f = 1.0MHz, VDS= -6 V)	Ciss	-	550	-	pF
Output Capacitance (VGS = 0 V, f = 1.0MHz, VDS= -6 V)	Coss	-	145.5	-	pF
Reverse Transfer Capacitance (VGS = 0 V, f = 1.0MHz, VDS= -6 V)	Crss	-	97.26	-	pF

**SWITCHING CHARACTERISTICS**

Turn-On Delay Time	(VDD = -6V, RL = 6 ID = -1A, VGEN = -4.5V RG = 6 )	td(on)	-	17.28	-	ns
Rise Time		tr	-	3.73	-	
Turn-Off Delay Time		td(off)	-	36.05	-	
Fall Time		tf	-	6.19	-	

**SOURCE–DRAIN DIODE CHARACTERISTICS**

Forward Voltage (VGS = 0 Vdc, ISD = -0.75 Adc)	VSD	-	-0.8	-1.2	V
---	-----	---	------	------	---

 3.Pulse Test: Pulse Width  $\leq$ 300  $\mu$ s, Duty Cycle  $\leq$ 2.0%.

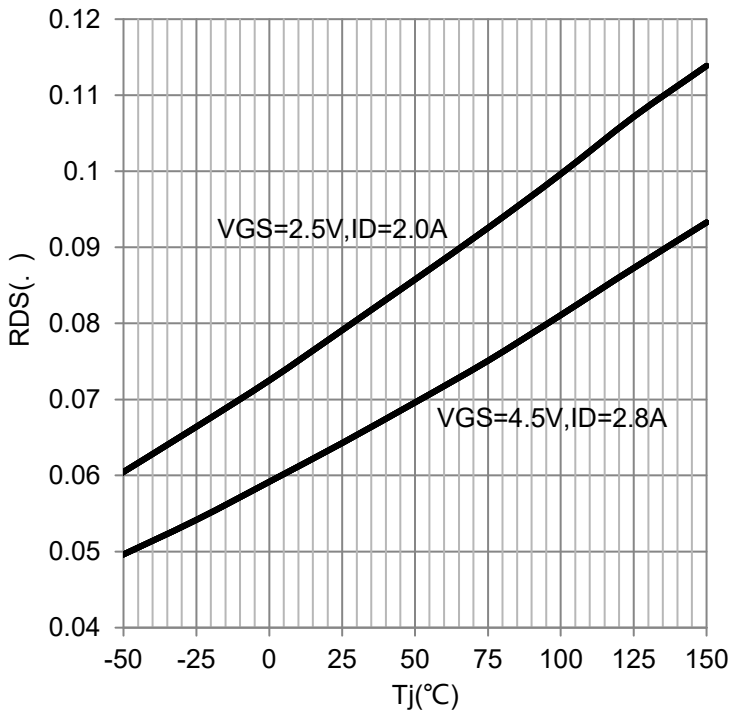
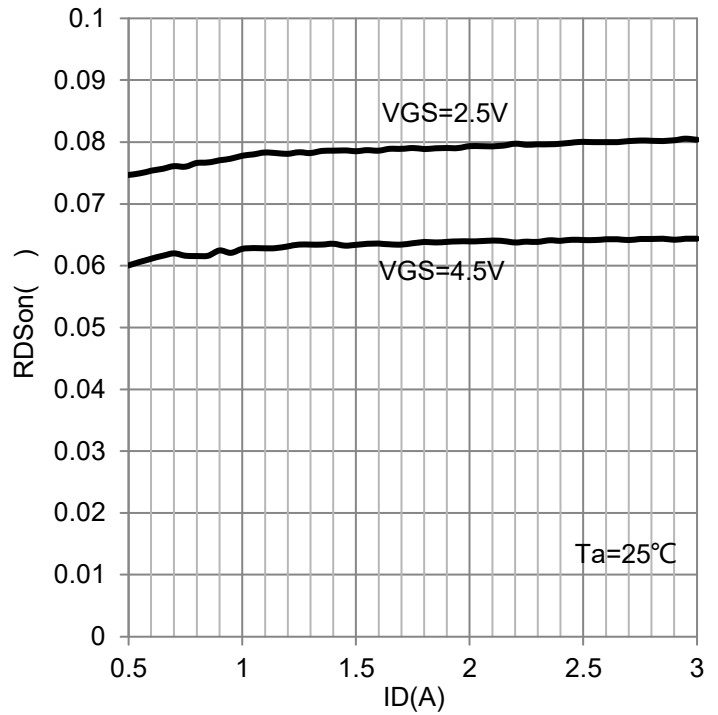
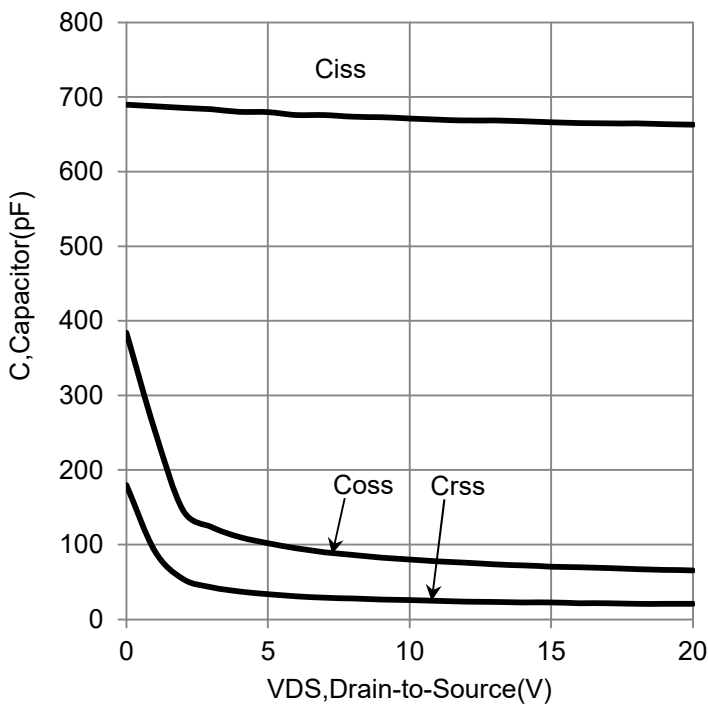
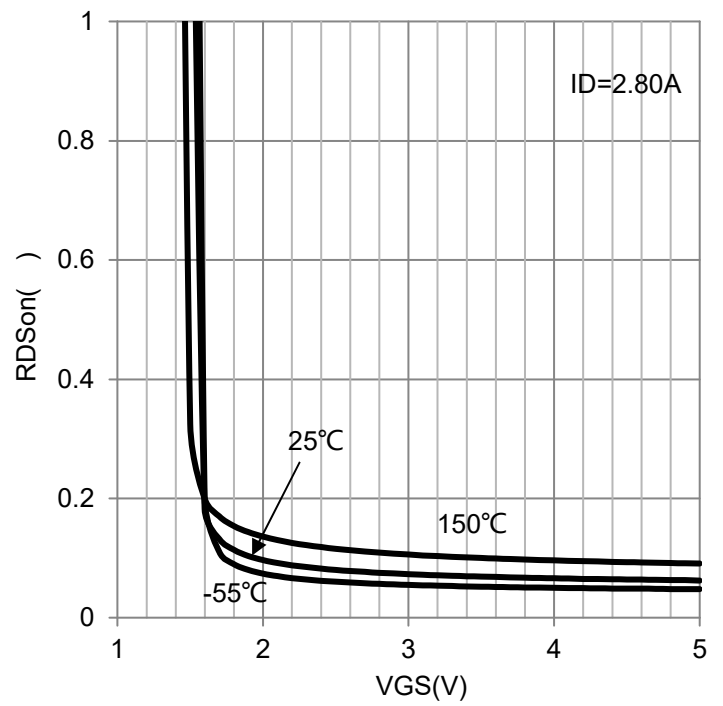
**7. ELECTRICAL CHARACTERISTICS CURVES**

**RDS(on) vs. Temperature**

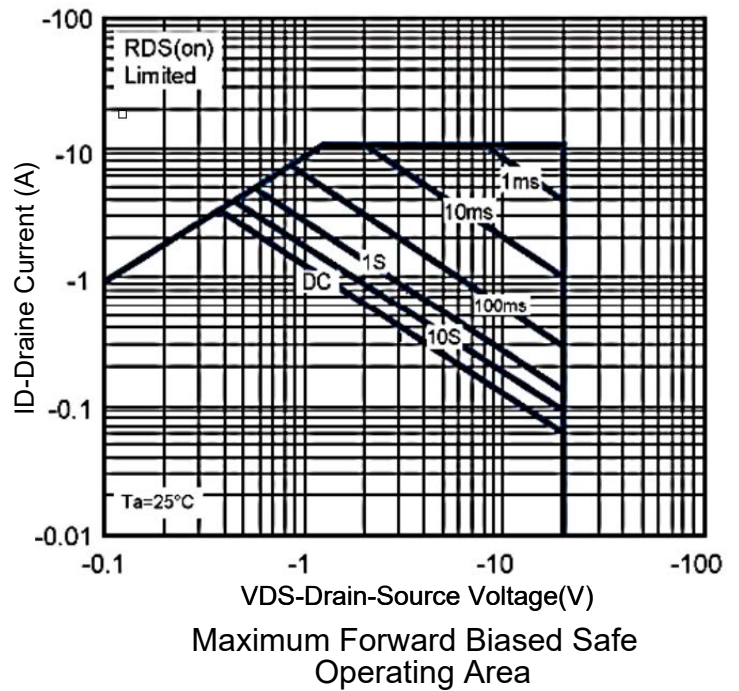
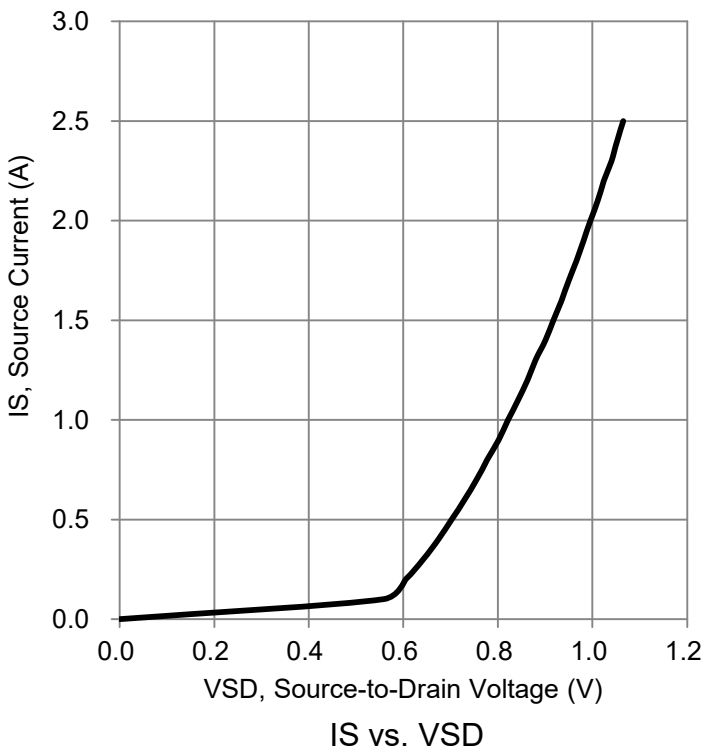
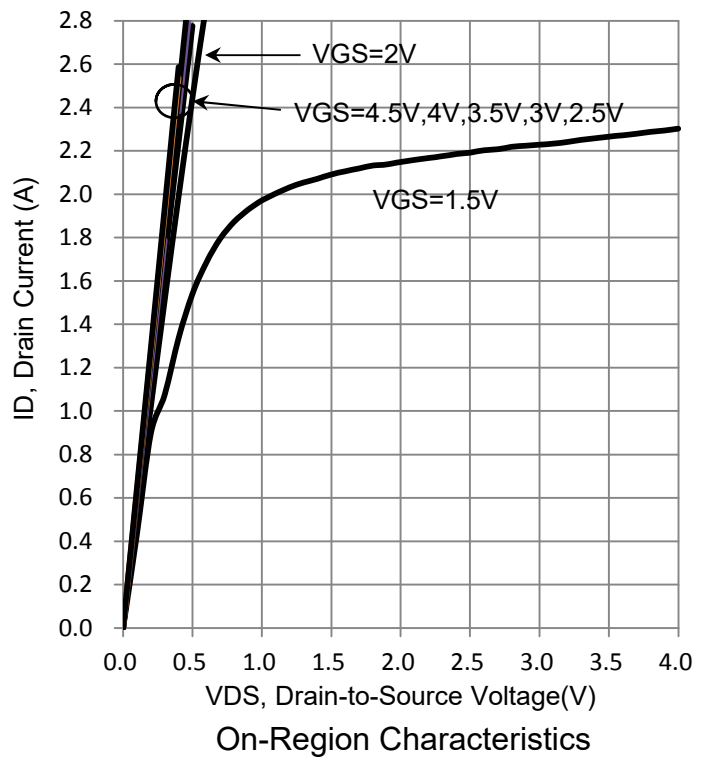
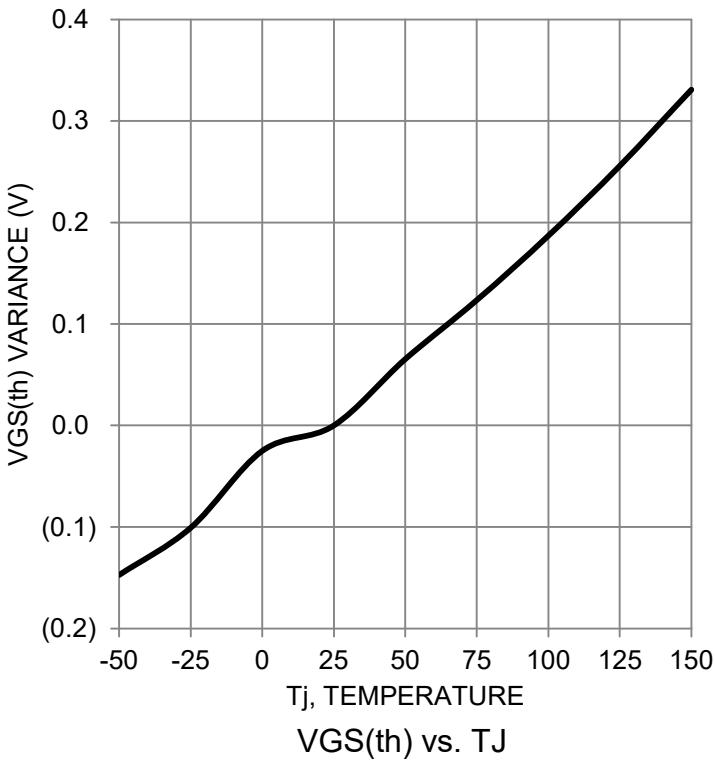
**RDS(on) vs. ID**

**Capacitor vs. VDS**

**RDS(on) vs. VGS**



7. ELECTRICAL CHARACTERISTICS CURVES(Con.)



### 8. OUTLINE AND DIMENSIONS

Notes:

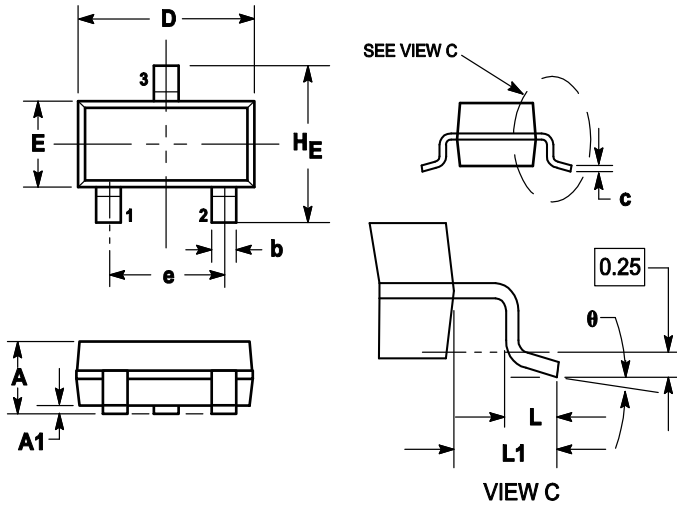
1. DIMENSIONING AND TOLERANCING PER ANSI Y14.5M, 1982.
2. CONTROLLING DIMENSION: MILLIMETERS.
3. MAXIMUM LEAD THICKNESS INCLUDES LEAD FINISH. MINIMUM LEAD THICKNESS IS THE MINIMUM THICKNESS OF BASE MATERIAL.
4. DIMENSIONS D AND E DO NOT INCLUDE MOLD FLASH, PROTRUSIONS OR GATE BURRS.



DIM	MILLIMETERS			INCHES		
	MIN	NOM	MAX	MIN	NOM	MAX
A	0.89	1	1.11	0.035	0.04	0.044
A1	0.01	0.06	0.1	0.001	0.002	0.004
b	0.37	0.44	0.5	0.015	0.018	0.02
c	0.09	0.13	0.18	0.003	0.005	0.007
D	2.80	2.9	3.04	0.11	0.114	0.12
E	1.20	1.3	1.4	0.047	0.051	0.055
e	1.78	1.9	2.04	0.07	0.075	0.081
L	0.10	0.2	0.3	0.004	0.008	0.012
L1	0.35	0.54	0.69	0.014	0.021	0.029
H <sub>E</sub>	2.10	2.4	2.64	0.083	0.094	0.104
$\theta$	0°	---	10°	0°	---	10°

### 9. SOLDERING FOOTPRINT

