

P2301A

S-P2301A

20V P-Channel Enhancement-Mode MOSFET

1. FEATURES

- $V_{DS} = -20V$
- $R_{DS(ON)}, V_{GS@-2.5V}, I_{DS@-2.0A} = 150m\Omega$
- $R_{DS(ON)}, V_{GS@-4.5V}, I_{DS@-2.8A} = 110m\Omega$
- We declare that the material of product compliance with RoHS requirements and Halogen Free.
- S- prefix for automotive and other applications requiring unique site and control change requirements; AEC-Q101 qualified and PPAP capable.

2. APPLICATIONS

- Power management in note book
- Portable equipment
- Battery powered system
- Load switch
- DSC

3. DEVICE MARKING AND ORDERING INFORMATION

Device	Marking	Shipping
P2301A	01A	3000/Tape&Reel

4. MAXIMUM RATINGS($T_a = 25^\circ C$)

Parameter	Symbol	Limits	Unit
Drain-Source Voltage	V_{DSS}	-20	V
Gate-to-Source Voltage – Continuous	V_{GS}	± 8	V
Drain Current(Note 1)			A
– Continuous $T_A = 25^\circ C$	I_D	-2	
– Pulsed	I_{DM}	-10	

5. THERMAL CHARACTERISTICS

Parameter	Symbol	Limits	Unit
Maximum Power Dissipation	PD	0.7	W
Thermal Resistance, Junction-to-Ambient(Note 1)	$R_{\theta JA}$	175	$^\circ C/W$
Junction and Storage temperature	T_J, T_{stg}	$-55 \sim +150$	$^\circ C$

1. The device mounted on 1in² FR5 board with 2 oz copper.

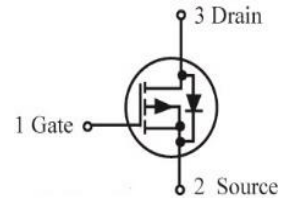
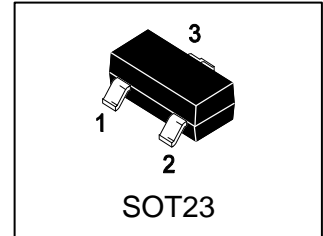

6. ELECTRICAL CHARACTERISTICS (Ta= 25°C)
OFF CHARACTERISTICS

Characteristic	Symbol	Min.	Typ.	Max.	Unit
Drain–Source Breakdown Voltage (VGS = 0, ID = -250μA)	VBRDSS	-20	-	-	V
Zero Gate Voltage Drain Current (VGS = 0, VDS = -20 V)	IDSS	-	-	-1	μA
Gate–Body Leakage Current, Forward (VGS = 8 V)	IGSSF	-	-	100	nA
Gate–Body Leakage Current, Reverse (VGS = - 8 V)	IGSSR	-	-	-100	nA

ON CHARACTERISTICS (Note 2)

Gate Threshold Voltage (VDS = VGS, ID = -250μA)	VGS(th)	-0.4	-0.6	-	V
Static Drain–Source On–State Resistance (VGS = -4.5 V, ID = -2.8 A) (VGS = -2.5 V, ID = -2 A)	RDS(on)	-	90 110	110 150	mΩ

DYNAMIC CHARACTERISTICS

Input Capacitance (VGS = 0 V, f = 1.0MHz, VDS= -15 V)	Ciss	-	480	-	pF
Output Capacitance (VGS = 0 V, f = 1.0MHz, VDS= -15 V)	Coss	-	46	-	pF
Reverse Transfer Capacitance (VGS = 0 V, f = 1.0MHz, VDS= -15 V)	Crss	-	10	-	pF

SWITCHING CHARACTERISTICS

Turn-On Delay Time	(VDS=-6V, RL =6Ω, RGEN=6Ω, VGS=-4.5V)	td(on)	-	50	-	ns
Rise Time		tr	-	30	-	
Turn-Off Delay Time		td(off)	-	40	-	
Fall Time		tf	-	11	-	

SOURCE–DRAIN DIODE CHARACTERISTICS

Forward Voltage (VGS = 0 V, ISD = -1 A)	VSD	-	-0.7	-1.4	V
--	-----	---	------	------	---

2.Pulse Test: Pulse Width ≤300 μs, Duty Cycle ≤2.0%.



7. ELECTRICAL CHARACTERISTICS CURVES

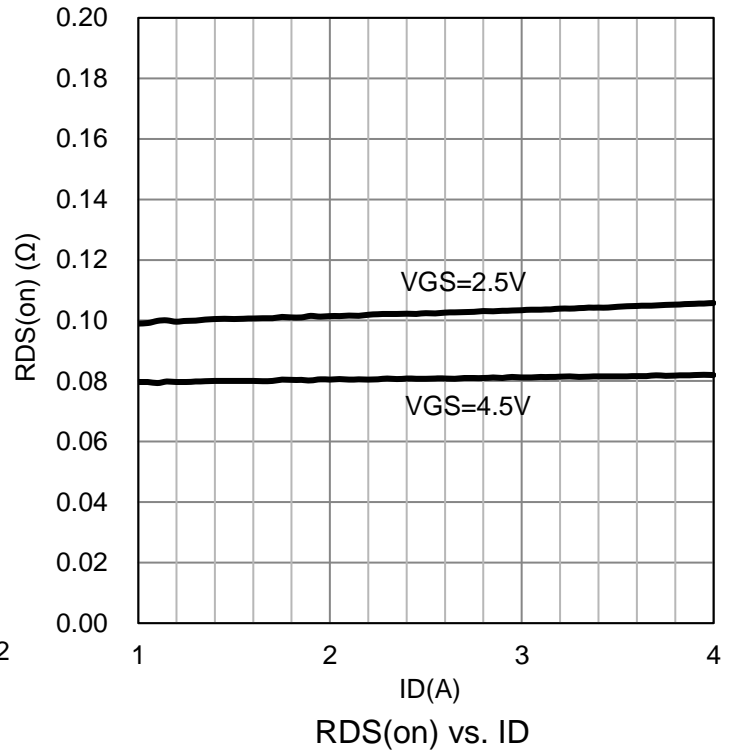
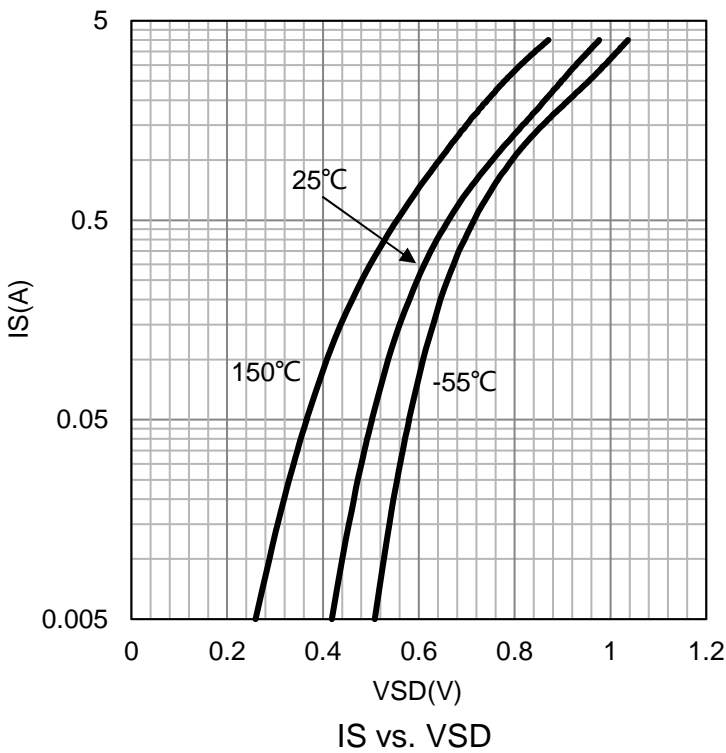
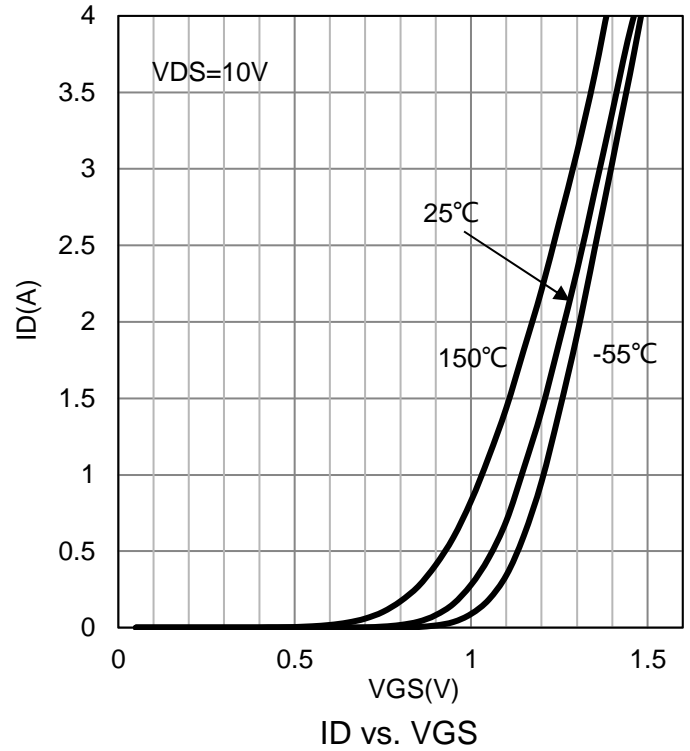
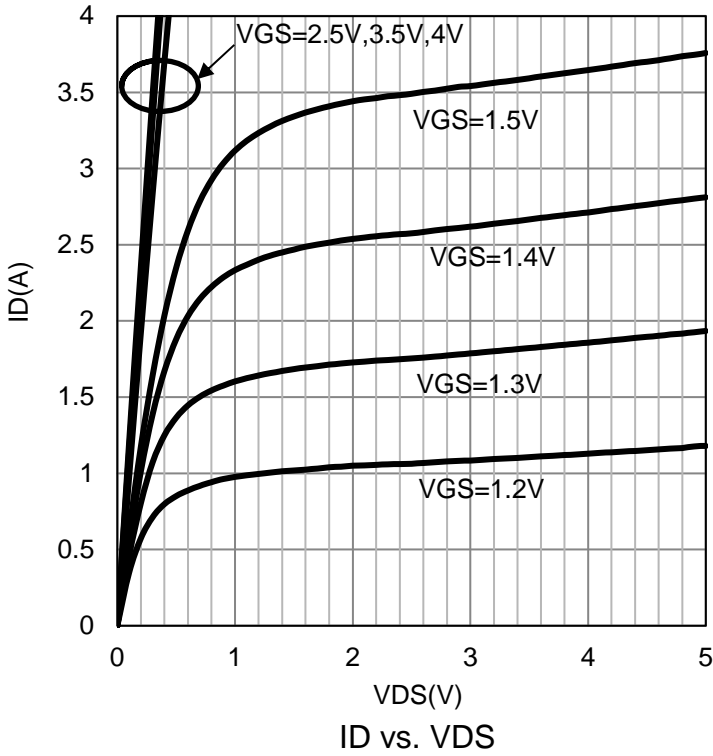

7. ELECTRICAL CHARACTERISTICS CURVES(Con.)

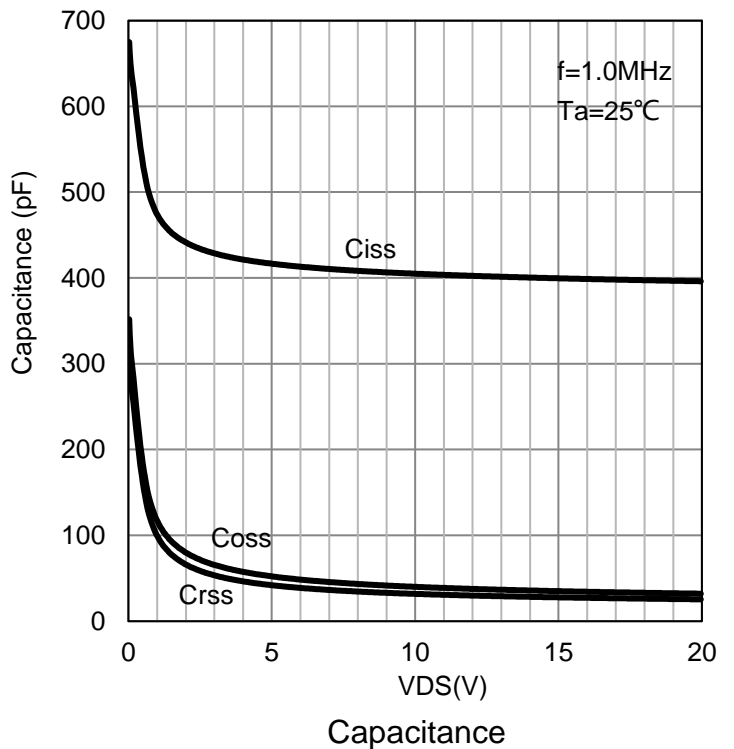
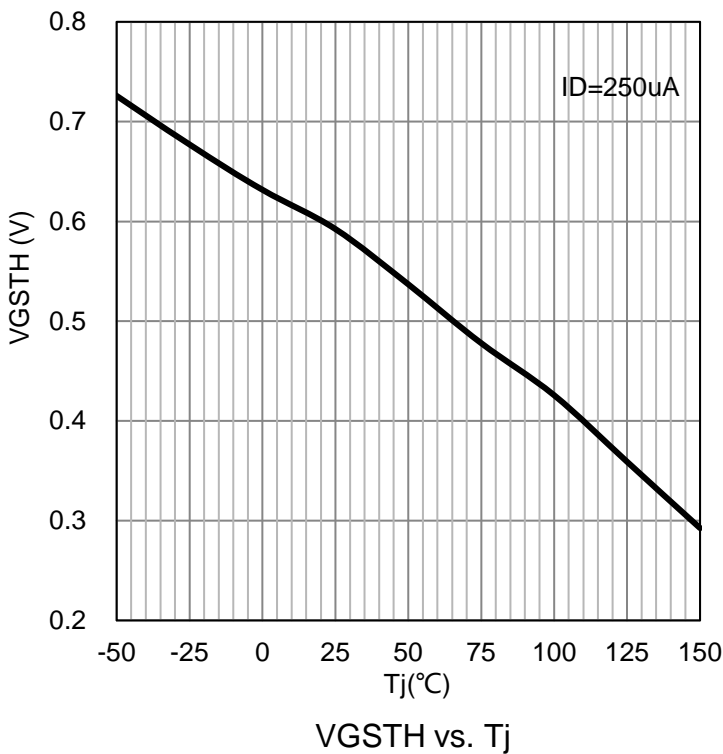
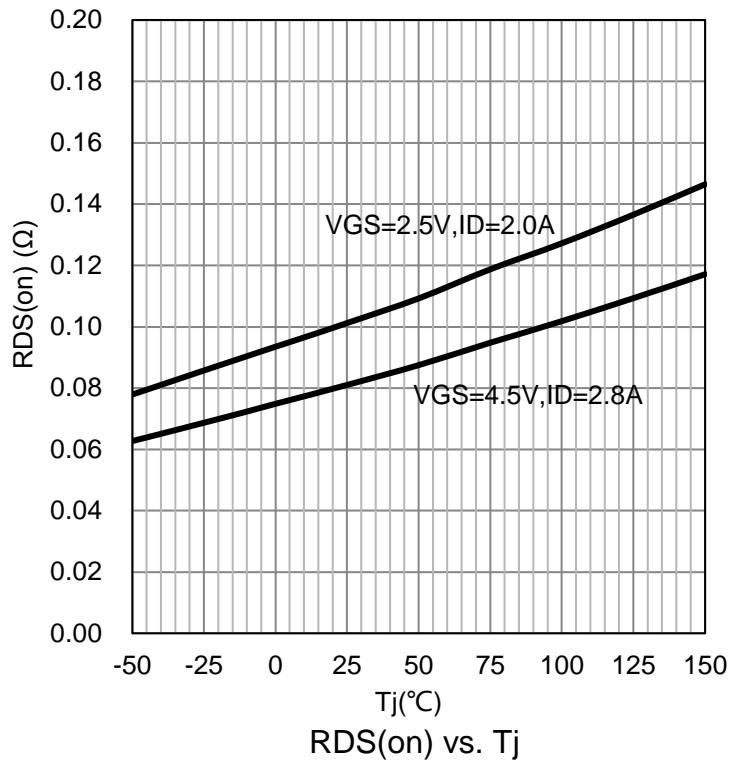
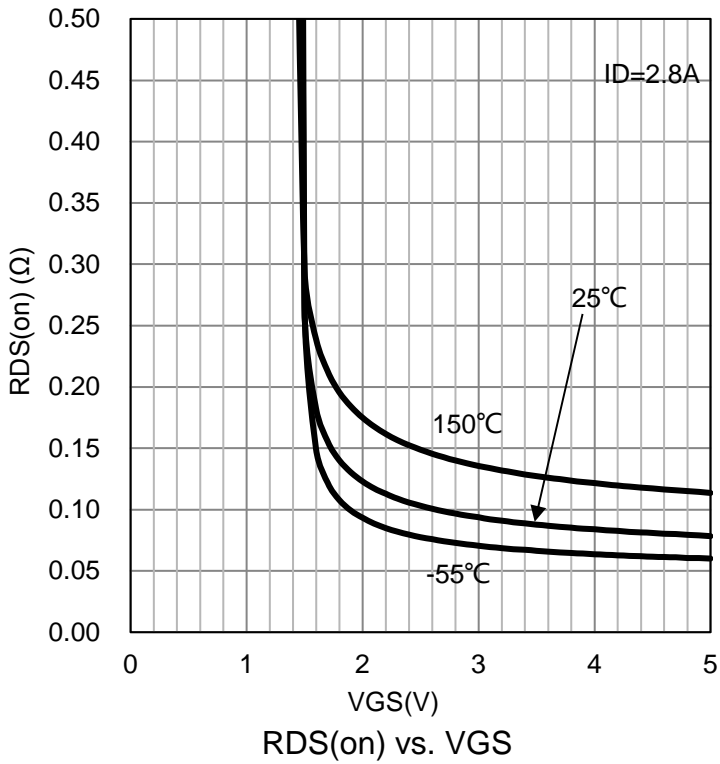

8. OUTLINE AND DIMENSIONS

Notes:

1. DIMENSIONING AND TOLERANCING PER ANSI Y14.5M, 1982.
2. CONTROLLING DIMENSION: MILLIMETERS.
3. MAXIMUM LEAD THICKNESS INCLUDES LEAD FINISH. MINIMUM LEAD THICKNESS IS THE MINIMUM THICKNESS OF BASE MATERIAL.
4. DIMENSIONS D AND E DO NOT INCLUDE MOLD FLASH, PROTRUSIONS OR GATE BURRS.

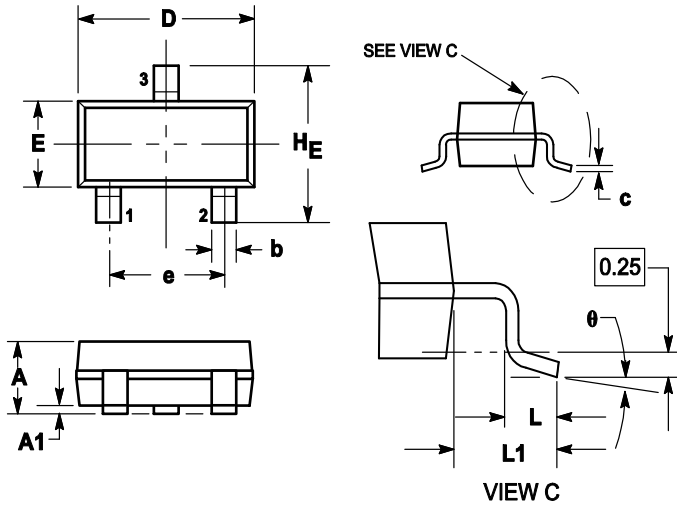

DIM	MILLIMETERS			INCHES		
	MIN	NOM	MAX	MIN	NOM	MAX
A	0.89	1	1.11	0.035	0.04	0.044
A1	0.01	0.06	0.1	0.001	0.002	0.004
b	0.37	0.44	0.5	0.015	0.018	0.02
c	0.09	0.13	0.18	0.003	0.005	0.007
D	2.80	2.9	3.04	0.11	0.114	0.12
E	1.20	1.3	1.4	0.047	0.051	0.055
e	1.78	1.9	2.04	0.07	0.075	0.081
L	0.10	0.2	0.3	0.004	0.008	0.012
L1	0.35	0.54	0.69	0.014	0.021	0.029
H _E	2.10	2.4	2.64	0.083	0.094	0.104
θ	0°	---	10°	0°	---	10°

9. SOLDERING FOOTPRINT
