

# P1221D

## 12V P-Channel Enhancement MOSFET

### 1. FEATURES

- Low Profile DFN 2.0x2.0x0.62 mm for Board Space Saving
- Ultra Low RDS(on)
- ESD Diode Protected Gate
- This is a Pb-Free Device
- We declare that the material of product are Halogen Free and compliance with RoHS requirements.

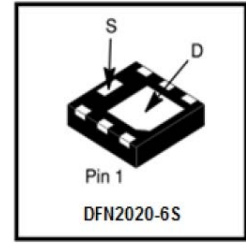

### 2. APPLICATIONS

- Battery Switch
- High Side Load Switch

### 3. ORDERING INFORMATION

Device	Marking	Shipping
P1221D	A12	4000/Tape&Reel

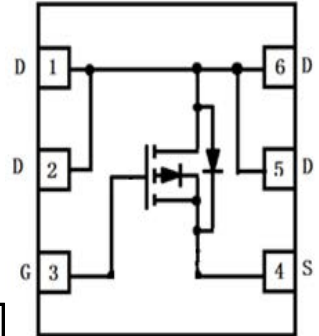

### 4. MAXIMUM RATINGS(Ta = 25°C unless otherwise stated)

Parameter	Symbol	Limits	Unit
Drain-to-Source Voltage	VDSS	-12	V
Gate-to-Source Voltage	VGS	±12	V
Drain Current (Note 1) Steady State	ID	-8	A
Pulsed Drain Current (tp = 10 μs)	IDM	-32	A
Power Dissipation (Note 1)	PD	1.7	W
Steady State		3.8	
Operating Junction and Storage Temperature Range	TJ , TSTG	-55 ~ +150	°C
Lead Temperature for Soldering Purposes (1/8" from case for 10 s)	TL	260	°C

1. Surface-mounted on FR4 board using 1 in sq pad size (Cu area = 1.127 in sq [1 oz] including traces)



**5. ELECTRICAL CHARACTERISTICS**

Parameter	Symbol	Test Condition	Min	Typ	Max	Unit
<b>NMOSFET</b>						
Drain-Source Breakdown Voltage	V(BR)DSS	VGS = 0 V, ID = 250 $\mu$ A	-12			V
Drain-to-Source Breakdown Voltage Temperature Coefficient	V(BR)DSS /TJ			10		mV/°C
Zero Gate Voltage Drain Current	IDSS	VGS = 0 V, VDS = -12 V, TJ = 25°C			-1	$\mu$ A
Gate-to-Source Leakage Current	IGSS	VDS = 0 V, VGS = $\pm$ 12 V			$\pm$ 10	$\mu$ A
Gate Threshold Voltage (Note2)	VGS(TH)	VGS = VDS, ID = 250 $\mu$ A			-1	V
Negative Threshold Temperature Coefficient (Note2)	VGS(TH) /TJ			3.0		mV/°C
Drain-to-Source On Resistance (Note2)	RDS(on)	VGS = -4.5 V, ID = -7 A		16	21.5	m $\Omega$
		VGS = -2.5 V, ID = -5 A		19	28	
		VGS = -1.8 V, ID = -2 A		35	48	
Forward Transconductance (Note2)	gFS	VDS = -5 V, ID = -3A		40		S
Input Capacitance	CISS	VGS = 0 V, f = 1 MHz, VDS = -15 V		2240		pF
Output Capacitance	COSS			290		
Reverse Transfer Capacitance	CRSS			260		
Total Gate Charge	QG(TOT)	VGS = -4.5 V, VDS = -15 V; ID = -4A		22		nC
Threshold Gate Charge	QG(TH)			1.0		
Gate-to-Source Charge	QGS			3.1		
Gate-to-Drain Charge	QGD			9.5		
Turn-On Delay Time (Note3)	td(ON)	VGS = -4.5 V, VDD = -15 V; ID = -4A, RG = 1 $\Omega$		11		ns
Rise Time (Note3)	tr			19		
Turn-Off Delay Time (Note3)	td(OFF)			160		
Fall Time (Note3)	tf			92		
Forward Diode Voltage	VSD	VGS = 0 V, IS = -1A	TJ = 25°C		-1.5	V
			TJ = 125°C		-0.5	

2. Pulse Test: pulse width  $\leq$  300  $\mu$ s, duty cycle  $\leq$  2%

3. Switching characteristics are independent of operating junction temperatures



**6.ELECTRICAL CHARACTERISTICS CURVES**

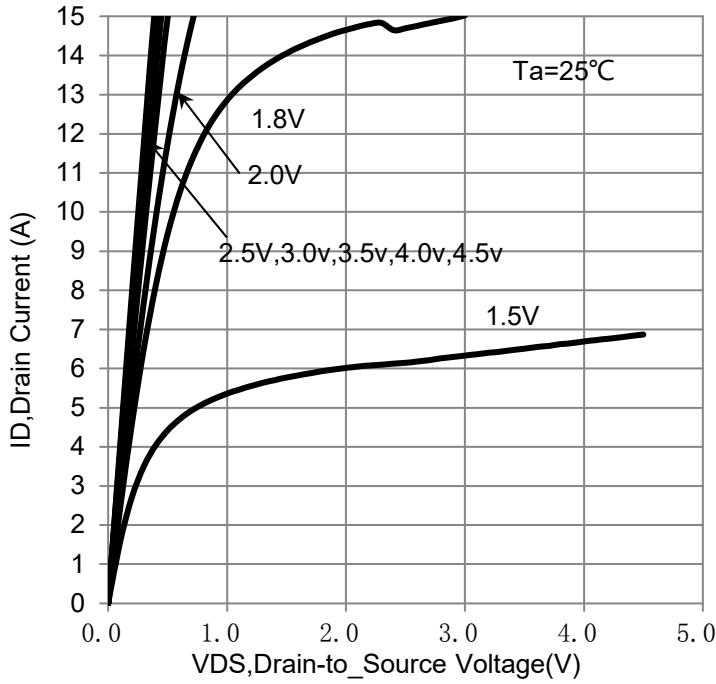

**On-Region Characteristics**

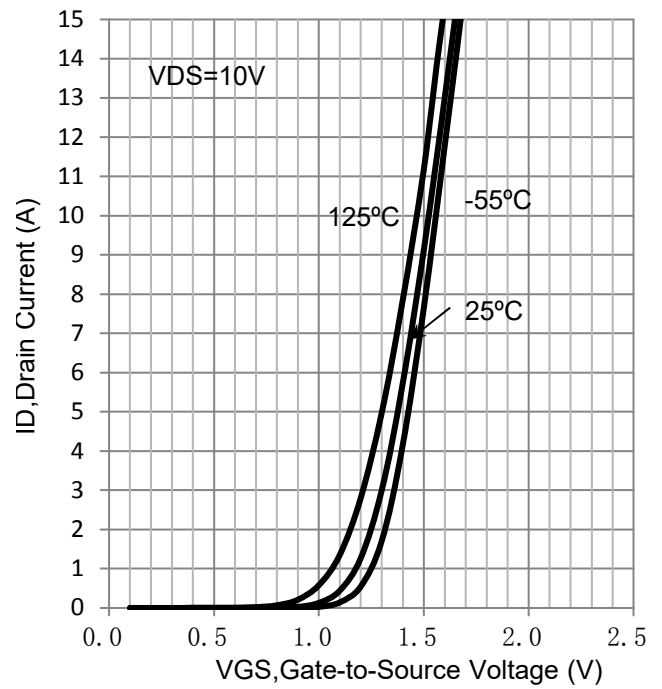

**Transfer Characteristics**

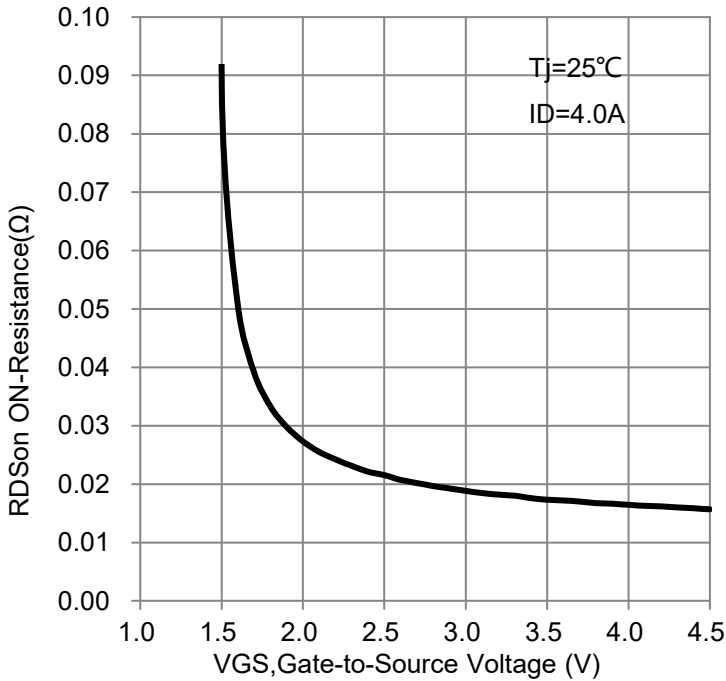

**On-Resistance vs. Gate-to-Source Voltage**

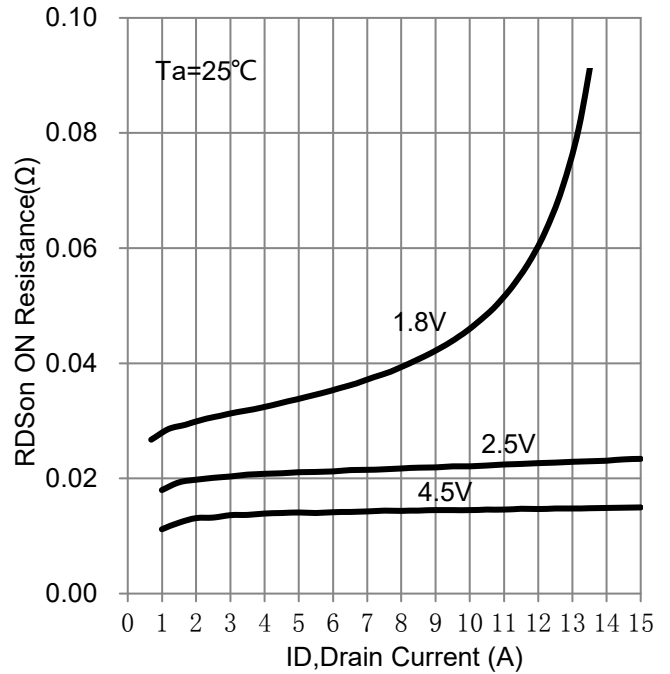

**On-Resistance vs. Drain Current and Gate Voltage**



**6.ELECTRICAL CHARACTERISTICS CURVES (Con.)**

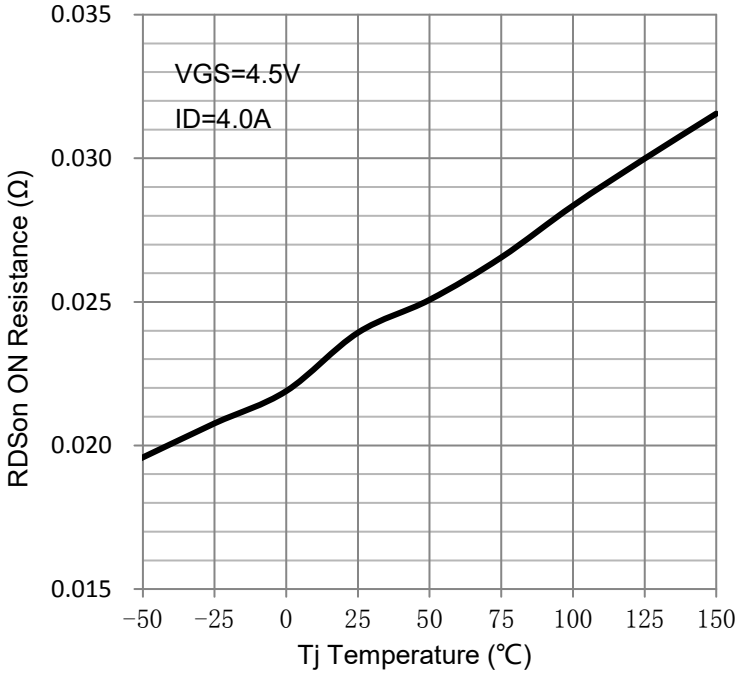

**On-Resistance Variation with Temperature**

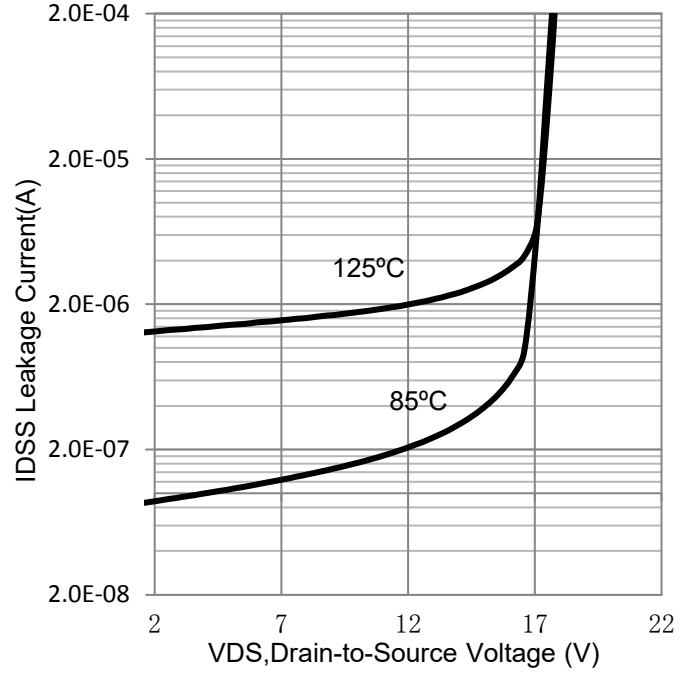

**Drain-to-Source Leakage Current vs. Voltage**

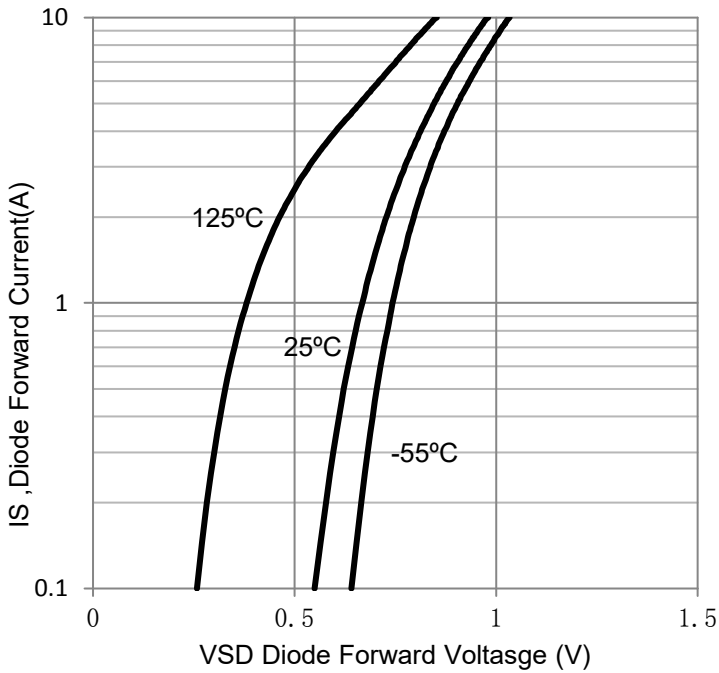

**Diode Forward Voltage vs. Current**

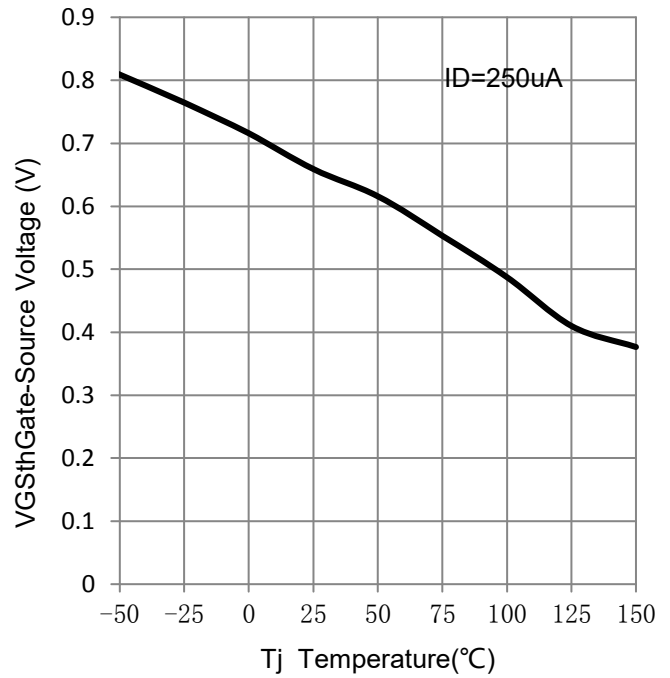

**Threshold Voltage**



**6.ELECTRICAL CHARACTERISTICS CURVES (Con.)**

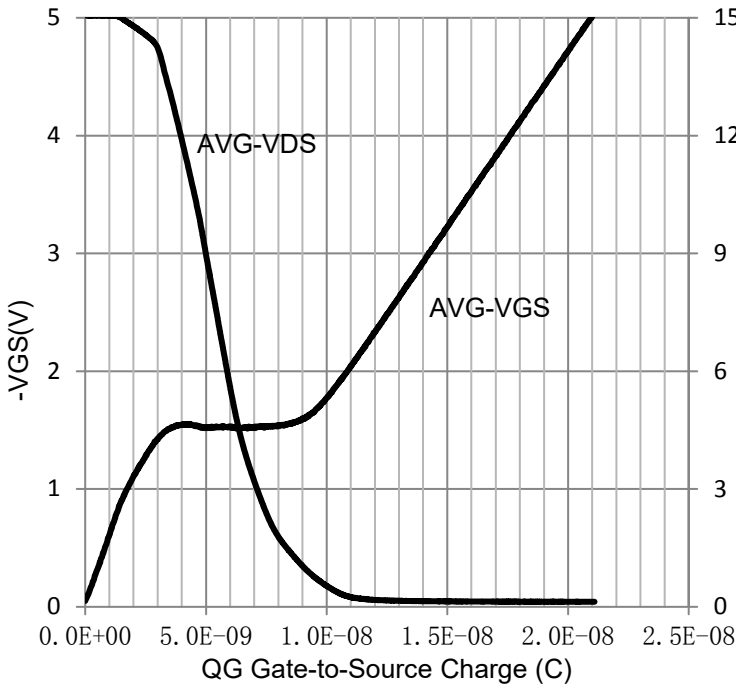

**Gate-to-Source and Drain-to-Source Voltage vs. Total Charge**

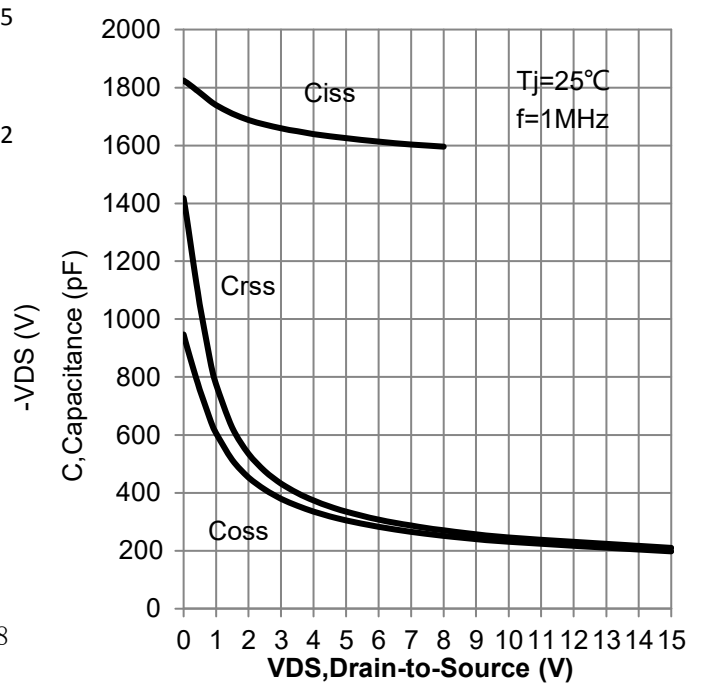

**Capacitance variation**

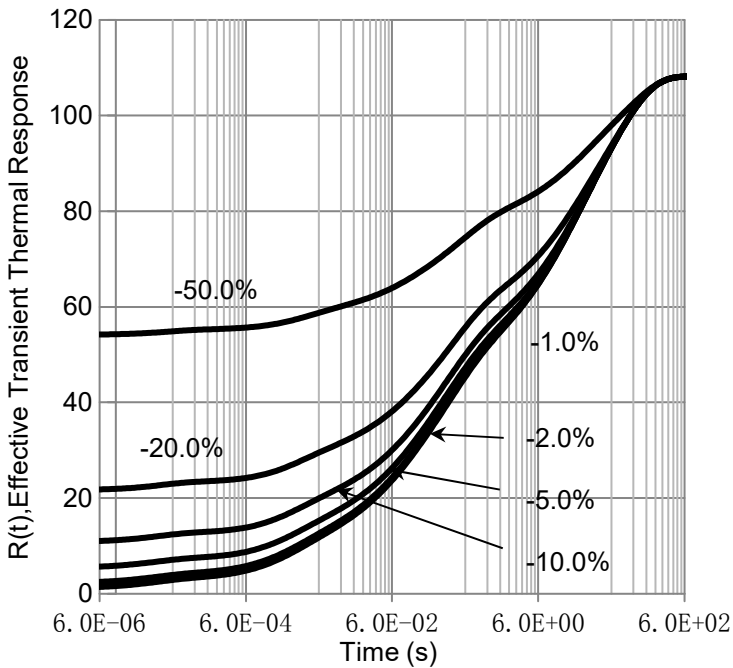

**FET Thermal Response**

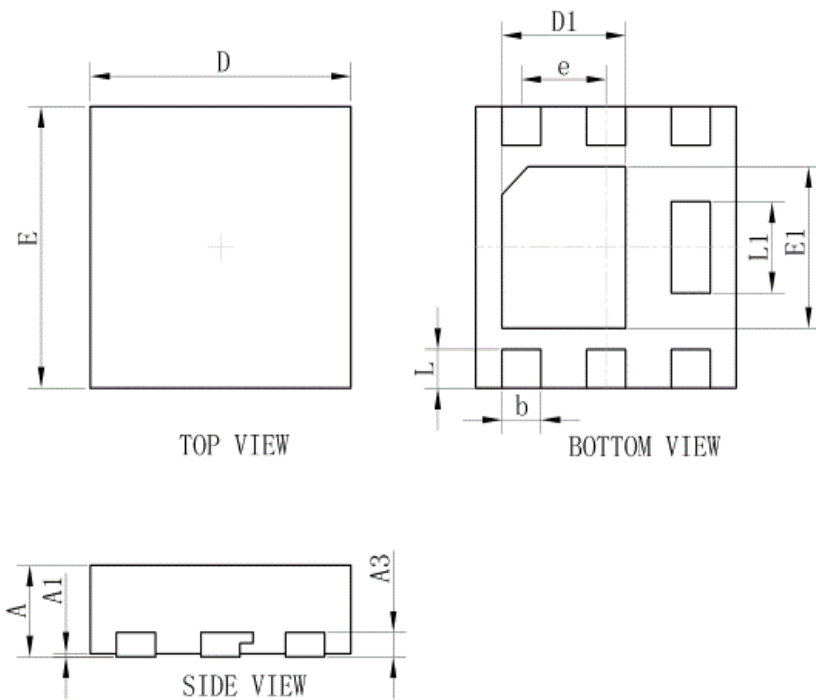

**7.OUTLINE AND DIMENSIONS**

DFN2020-6S			
DIM	MIN	NOR	MAX
A	0.60	0.65	0.70
A1	0.01	0.03	0.05
b	0.25	0.30	0.35
D	1.95	2.00	2.05
E	1.95	2.00	2.05
e	0.65TYP.		
L	0.23	0.28	0.33
L1	0.60	0.65	0.65
D1	0.90	0.95	1.00
E1	1.10	1.15	1.20
A3	0.152REF		
All Dimensions in mm			

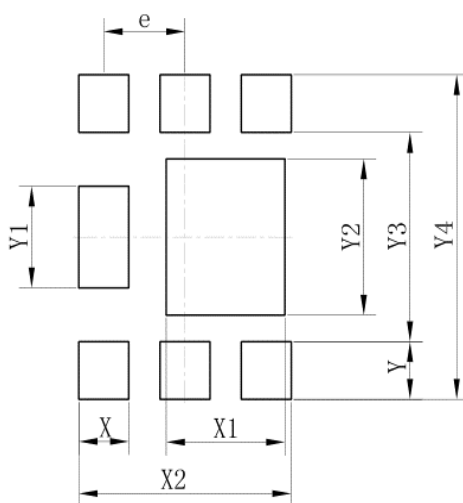
**8.SOLDERING FOOTPRINT**

DFN2020-6S	
Dim	(mm)
X	0.40
X1	0.95
X2	1.70
e	0.65
Y	0.43
Y1	0.75
Y2	1.15
Y3	1.54
Y4	2.39

