

Small Signal MOSFET

25 V, 0.75 A, Single, N-Channel,
ESD Protection, SOT-23

Features

- Advance Planar Technology for Fast Switching, Low $R_{DS(on)}$
- Higher Efficiency Extending Battery Life
- This is a Pb-Free Device
- S- Prefix for Automotive and Other Applications Requiring Unique Site and Control Change Requirements; AEC-Q101 Qualified and PPAP Capable.

Applications

- Boost and Buck Converter
- Load Switch
- Battery Protection

NTK2575L
S-NTK2575L

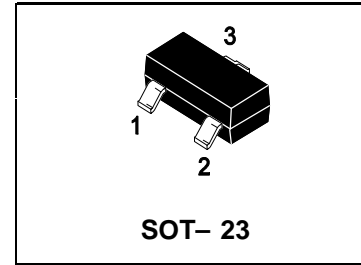

$V_{(BR)DSS}$	$R_{DS(on)}$ Typ	I_D Max
25 V	249 mΩ @ 4.5 V	0.75 A
	299 mΩ @ 2.7 V	

MAXIMUM RATINGS ($T_J = 25^\circ\text{C}$ unless otherwise noted)

Rating		Symbol	Value	Unit
Drain-to-Source Voltage		V_{DSS}	25	V
Gate-to-Source Voltage		V_{GS}	± 8.0	V
Drain Current	$t < 5$ s	I_D	0.75	A
Continuous Drain Current (Note 1)	Steady State		$T_A = 25^\circ\text{C}$	0.7
		$T_A = 75^\circ\text{C}$	0.6	A
Power Dissipation (Note 1)	Steady State	P_D	0.28	W
Power Dissipation (Note 1)	$t \leq 5$ s	P_D	0.35	W
Pulsed Drain Current	$t_p = 10$ μs	I_{DM}	3.0	A
Operating Junction and Storage Temperature		T_J, T_{STG}	-55 to +150	$^\circ\text{C}$
Source Current (Body Diode) (Note 1)		I_S	0.3	A
Lead Temperature for Soldering Purposes (1/8" from case for 10 s)		T_L	260	$^\circ\text{C}$
ESD Rating - Machine Model			250	V

PIN CONNECTIONS

SOT-23 (3- Leads)

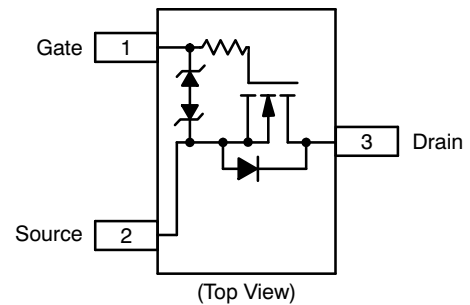

MARKING DIAGRAM

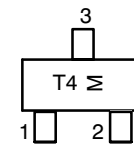

T4 = Specific Device Code
M = Month Code

THERMAL RESISTANCE RATINGS

Rating	Symbol	Max	Unit
Junction-to-Ambient - Steady State (Note 1)	$R_{\theta JA}$	450	$^\circ\text{C/W}$
Junction-to-Ambient - $t \leq 5$ s (Note 1)	$R_{\theta JA}$	375	$^\circ\text{C/W}$

Maximum ratings are those values beyond which device damage can occur. Maximum ratings applied to the device are individual stress limit values (not normal operating conditions) and are not valid simultaneously. If these limits are exceeded, device functional operation is not implied, damage may occur and reliability may be affected.

1. Surface mounted on FR4 board using 1 in sq pad size (Cu area = 1.127 in sq [1 oz] including traces).

Device	Package	Shipping
NTK2575L S-NTK2575L	SOT-23 (Pb-Free)	3000/Tape & Reel



ELECTRICAL CHARACTERISTICS (T_J = 25°C unless otherwise noted)

Characteristic	Symbol	Test Condition	Min	Typ	Max	Unit
----------------	--------	----------------	-----	-----	-----	------

OFF CHARACTERISTICS

Drain-to-Source Breakdown Voltage	V _{(BR)DSS}	V _{GS} = 0 V, I _D = 250 μA	25			V
Drain-to-Source Breakdown Voltage Temperature Coefficient	V _{(BR)DSS} /T _J			30		mV/°C
Zero Gate Voltage Drain Current	I _{DSS}	V _{GS} = 0 V, V _{DS} = 20 V	T _J = 25°C		0.5	μA
			T _J = 70°C		2.0	
			T _J = 125°C		5.0	
Gate-to-Source Leakage Current	I _{GSS}	V _{DS} = 0 V, V _{GS} = 8.0 V			3	uA

ON CHARACTERISTICS (Note 2)

Gate Threshold Voltage	V _{GS(TH)}	V _{GS} = V _{DS} , I _D = 250 μA	0.5		1.5	V
Negative Threshold Temperature Coefficient	V _{GS(TH)} /T _J			-2.0		mV/°C
Drain-to-Source On Resistance	R _{DS(on)}	V _{GS} = 4.5 V, I _D = 0.6 A		249	350	mΩ
		V _{GS} = 2.7 V, I _D = 0.2 A		299	400	
		V _{GS} = 4.5 V, I _D = 1.2 A		260		
Forward Transconductance	g _{FS}	V _{DS} = 5.0 V, I _D = 0.5 A		0.5		S

CHARGES AND CAPACITANCES

Input Capacitance	C _{ISS}	V _{GS} = 0 V, f = 1.0 MHz, V _{DS} = 10 V		49	60	pF
Output Capacitance	C _{OSS}			22.4	30	
Reverse Transfer Capacitance	C _{RSS}			8.0	12	
Total Gate Charge	Q _{G(TOT)}	V _{GS} = 4.5 V, V _{DS} = 15 V, I _D = 0.8 A		1.2	1.5	nC
Threshold Gate Charge	Q _{G(TH)}			0.2		
Gate-to-Source Charge	Q _{GS}			0.28	0.50	
Gate-to-Drain Charge	Q _{GD}			0.3	0.40	

SWITCHING CHARACTERISTICS (Note 3)

Turn-On Delay Time	t _{d(ON)}	V _{GS} = 4.5 V, V _{DS} = 15 V, I _D = 0.7 A, R _G = 51 Ω		5.0	12	ns
Rise Time	t _r			8.2	8.0	
Turn-Off Delay Time	t _{d(OFF)}			23	35	
Fall Time	t _f			41	60	

DRAIN-SOURCE DIODE CHARACTERISTICS

Forward Diode Voltage	V _{SD}	V _{GS} = 0 V, I _S = 0.6 A	T _J = 25°C		0.82	1.20	V
-----------------------	-----------------	---	-----------------------	--	------	------	---

- Pulse Test: pulse width ≤ 300 μs, duty cycle ≤ 2%.
- Switching characteristics are independent of operating junction temperatures.



TYPICAL PERFORMANCE CURVES ($T_J = 25^\circ\text{C}$ unless otherwise noted)

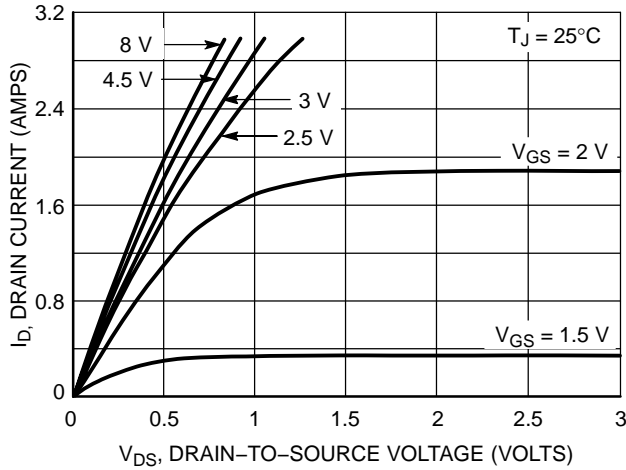

Figure 1. On-Region Characteristics

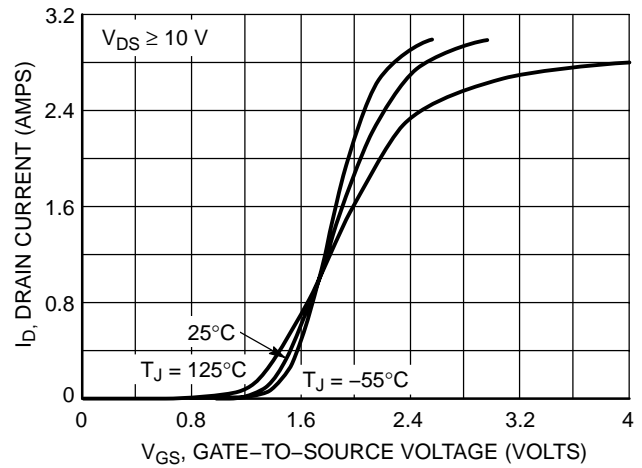

Figure 2. Transfer Characteristics

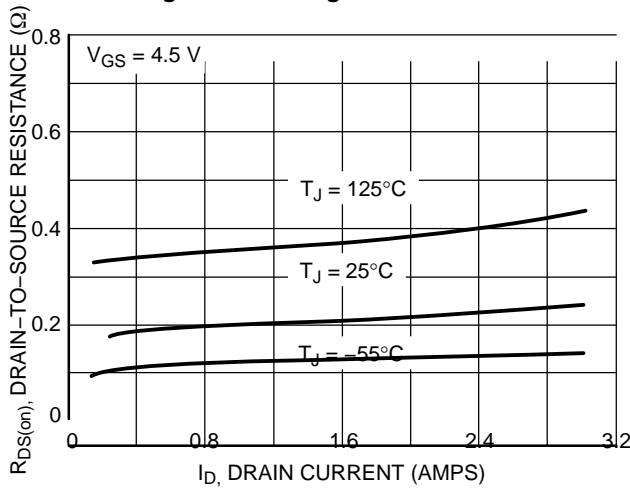

Figure 3. On-Resistance vs. Drain Current and Temperature

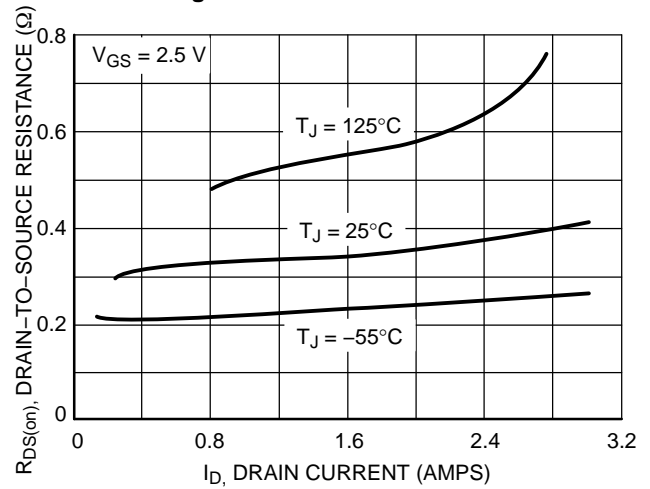

Figure 4. On-Resistance vs. Drain Current and Gate Voltage

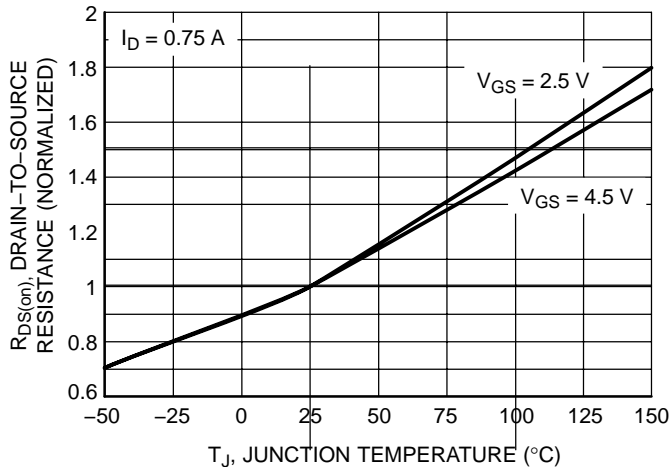

Figure 5. On-Resistance Variation with Temperature

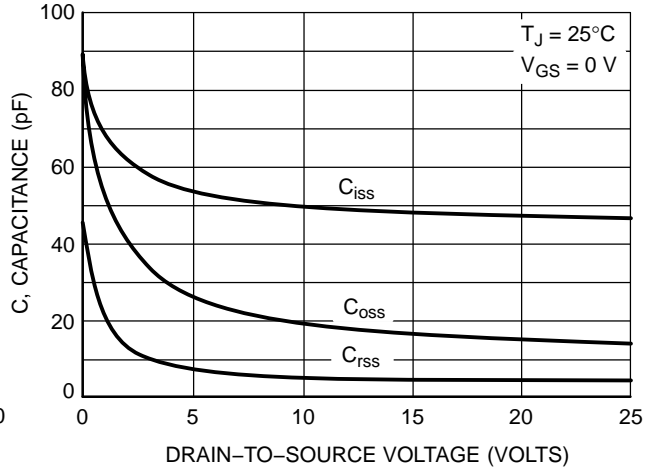

Figure 6. Capacitance Variation



TYPICAL PERFORMANCE CURVES ($T_J = 25^\circ\text{C}$ unless otherwise noted)

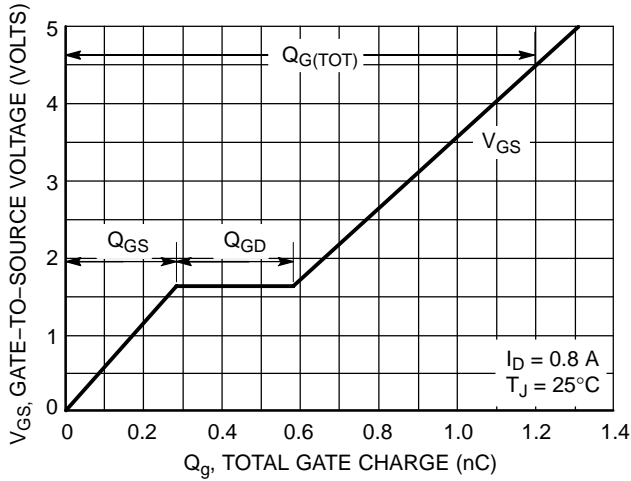

Figure 7. Gate-to-Source and Drain-to-Source Voltage vs. Total Charge

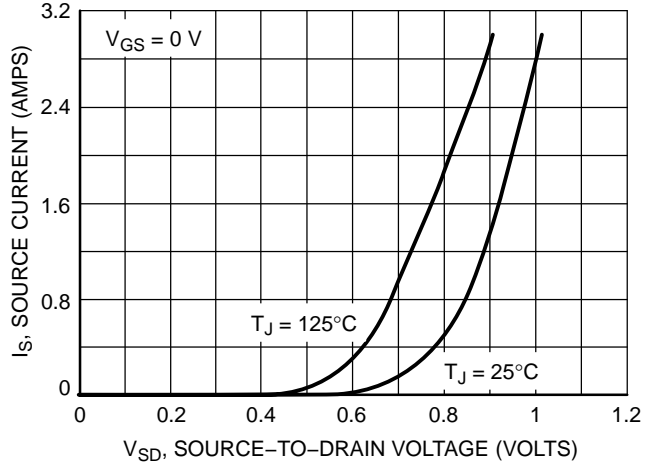

Figure 8. Diode Forward Voltage vs. Current



NTK2575L , S-NTK2575L

SOT-23

NOTES:

1. DIMENSIONING AND TOLERANCING PER ANSI Y14.5M,1982
2. CONTROLLING DIMENSION: INCH.

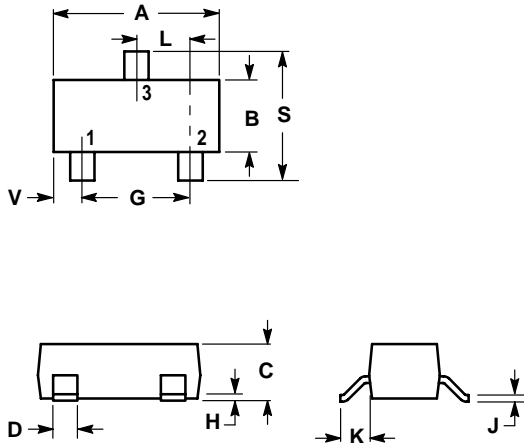

DIM	INCHES		MILLIMETERS	
	MIN	MAX	MIN	MAX
A	0.1102	0.1197	2.80	3.04
B	0.0472	0.0551	1.20	1.40
C	0.0350	0.0440	0.89	1.11
D	0.0150	0.0200	0.37	0.50
G	0.0701	0.0807	1.78	2.04
H	0.0005	0.0040	0.013	0.100
J	0.0034	0.0070	0.085	0.177
K	0.0140	0.0285	0.35	0.69
L	0.0350	0.0401	0.89	1.02
S	0.0830	0.1039	2.10	2.64
V	0.0177	0.0236	0.45	0.60

SOLDERING FOOTPRINT

