

N4812L

30V N-Channel Enhancement-Mode MOSFET

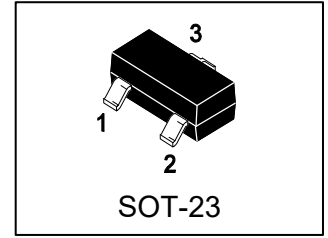

1. FEATURES

- VDS= 30V
- We declare that the material of product compliance with RoHS requirements and Halogen Free.

2. APPLICATIONS

- High density cell design for ultra low on-resistance
- Advanced trench process technology
- High power and current handling capability

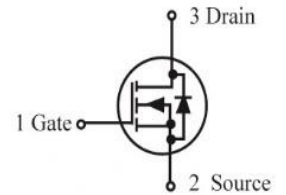

3. DEVICE MARKING AND ORDERING INFORMATION

Device	Marking	Shipping
N4812L	N48	3000/Tape&Reel

4. MAXIMUM RATINGS(Ta = 25°C)

Parameter	Symbol	Limits	Unit
Drain–Source Voltage	VDSS	30	V
Gate–to–Source Voltage – Continuous	VGS	±20	V
Drain Current			A
– Continuous TA = 25°C	ID	6	
– Pulsed(Note 1)	IDM	30	

5. THERMAL CHARACTERISTICS

Parameter	Symbol	Limits	Unit
Maximum Power Dissipation	PD	1.4	W
Thermal Resistance, Junction–to–Ambient(Note 2)	RθJA	90	°C/W
Junction and Storage temperature	TJ, Tstg	–55~+150	°C

1. Repetitive Rating: Pulse width limited by the Maximum junction temperature.
2. 1-in² 2oz Cu PCB board.



6. ELECTRICAL CHARACTERISTICS (Ta= 25°C)

Characteristic	Symbol	Min.	Typ.	Max	Unit	
Static						
Drain–Source Breakdown Voltage (VGS = 0, ID = 250μA)	V(BR)DSS	30	-	-	V	
Zero Gate Voltage Drain Current (VDS=24V, VGS=0V)	IDSS	-	-	1	μA	
Gate–Body Leakage Current, Forward (VDS = 0 V, VGS = 20 V)	IGSSF	-	-	100	nA	
Gate–Body Leakage Current, Reverse (VDS = 0 V, VGS = -20 V)	IGSSR	-	-	-100	nA	
Gate Threshold Voltage (VDS = VGS, ID = 250μA)	VGS(th)	1.0	1.5	3.0	V	
Static Drain–Source On–State Resistance (VGS = 10 V, ID = 6 A) (VGS = 4.5 V, ID = 5 A)	RDS(on)	- -	22 35	38 55	mΩ	
Dynamic						
Input Capacitance (VGS = 0 V, f = 1.0MHz, VDS= 15 V)	Ciss	-	610	-	pF	
Output Capacitance (VGS = 0 V, f = 1.0MHz, VDS= 15 V)	Coss	-	100	-	pF	
Reverse Transfer Capacitance (VGS = 0 V, f = 1.0MHz, VDS= 15 V)	Crss	-	77	-	pF	
Turn-On Delay Time	(VDD = 15V, RL =15Ω, ID = 1A, VGEN = 10V RG = 6Ω)	td(on)	-	9	-	ns
Rise Time		tr	-	14	-	
Turn-Off Delay Time		td(off)	-	30	-	
Fall Time		tf	-	5	-	
Forward Voltage (VGS = 0 V, ISD = 1 A)	VSD	-	-	1.3	V	
Max.Diode Forward Current	IS	-	-	3	A	

3.Pulse Test: Pulse Width ≤300 μs, Duty Cycle ≤2.0%.

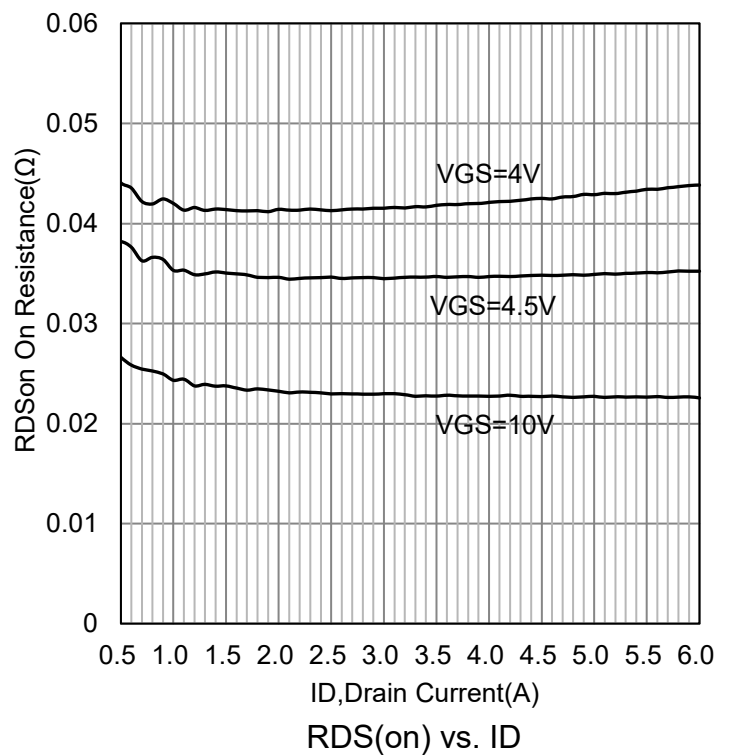
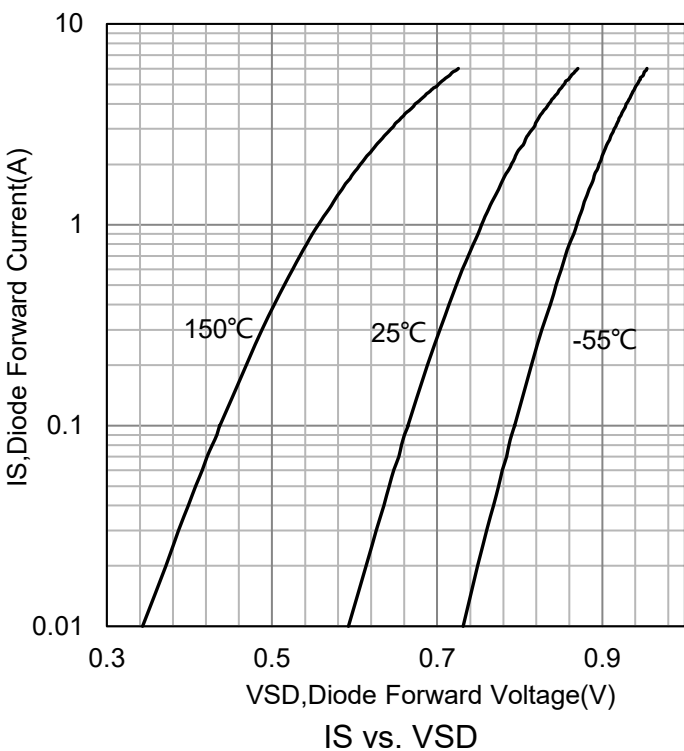
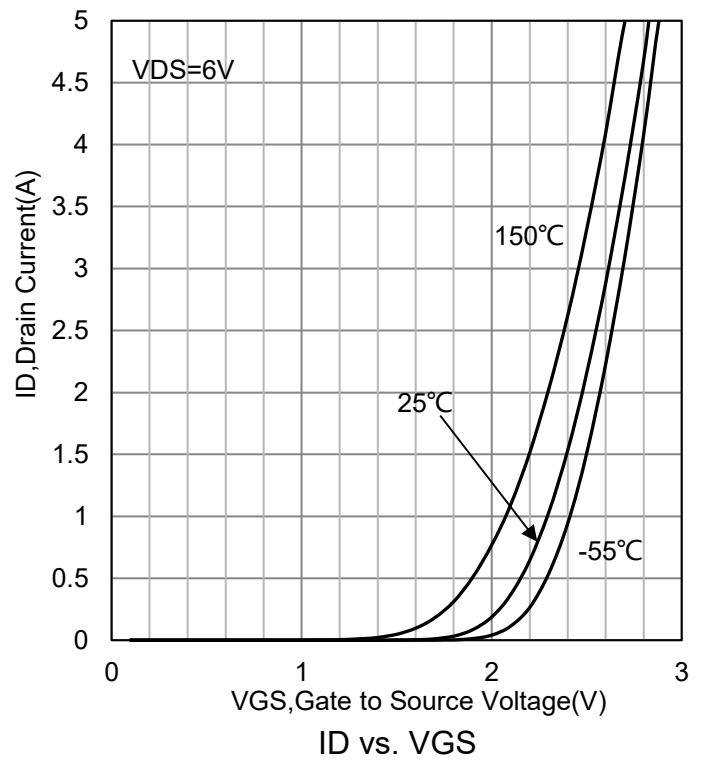
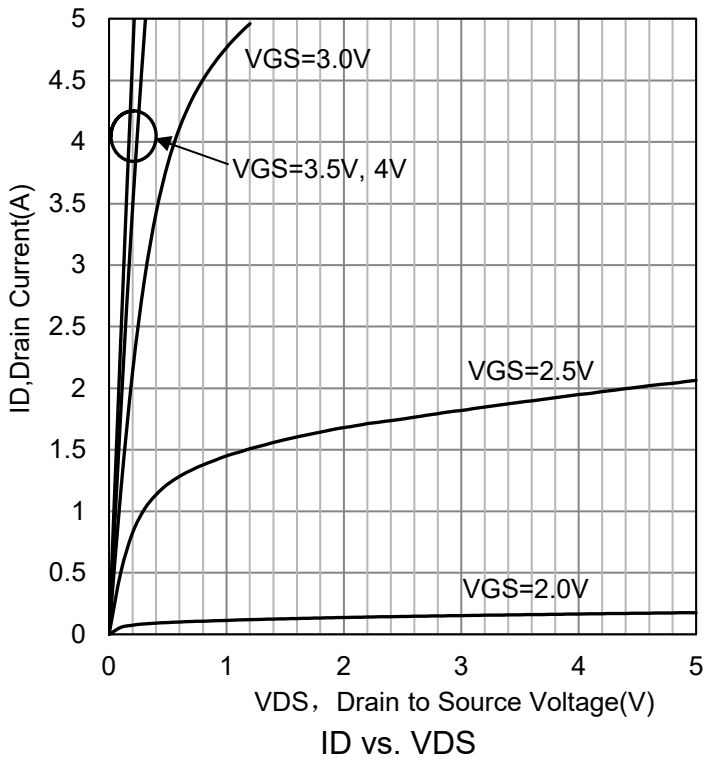

7. ELECTRICAL CHARACTERISTICS CURVES

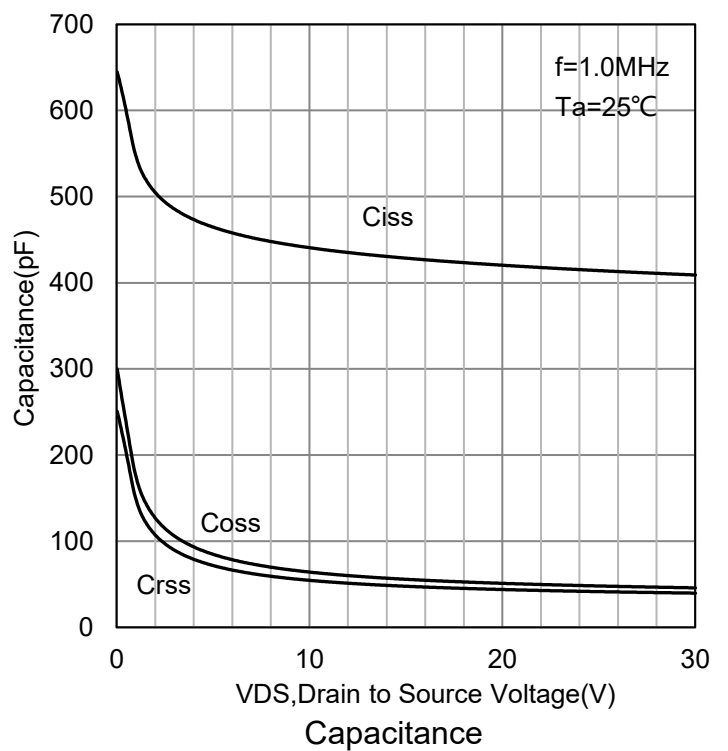
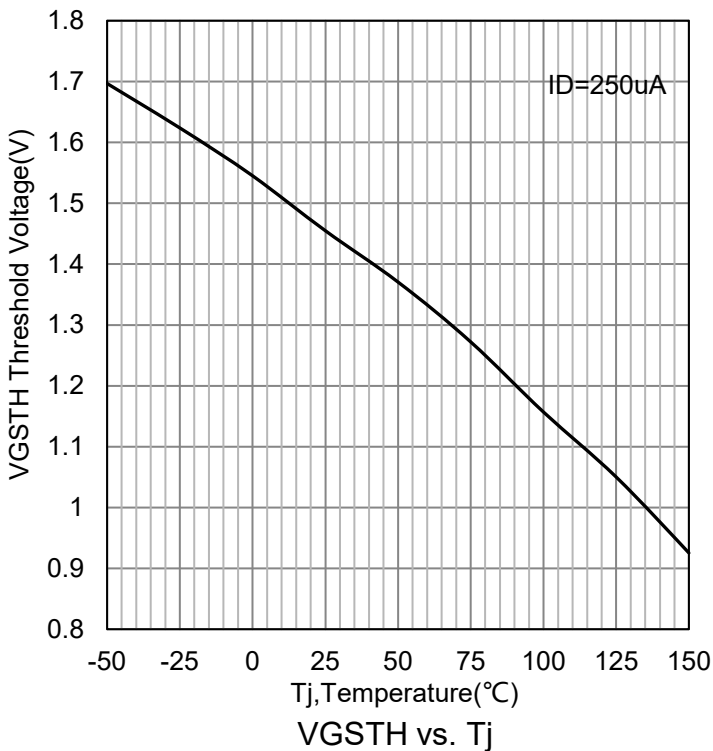
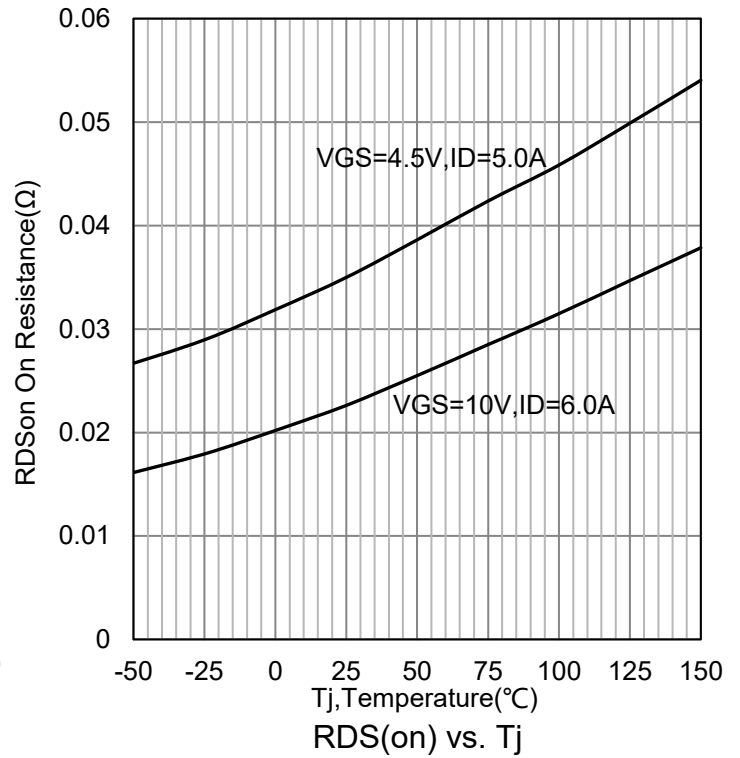
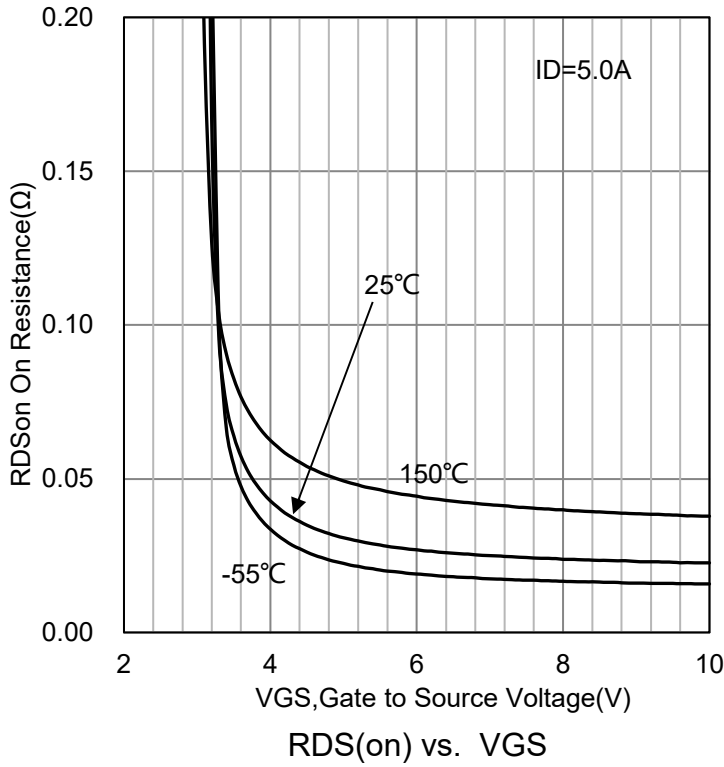
7. ELECTRICAL CHARACTERISTICS CURVES (Con.)

8. OUTLINE AND DIMENSIONS

Notes:

1. DIMENSIONING AND TOLERANCING PER ANSI Y14.5M, 1982.
2. CONTROLLING DIMENSION: MILLIMETERS.
3. MAXIMUM LEAD THICKNESS INCLUDES LEAD FINISH. MINIMUM LEAD THICKNESS IS THE MINIMUM THICKNESS OF BASE MATERIAL.
4. DIMENSIONS D AND E DO NOT INCLUDE MOLD FLASH, PROTRUSIONS OR GATE BURRS.

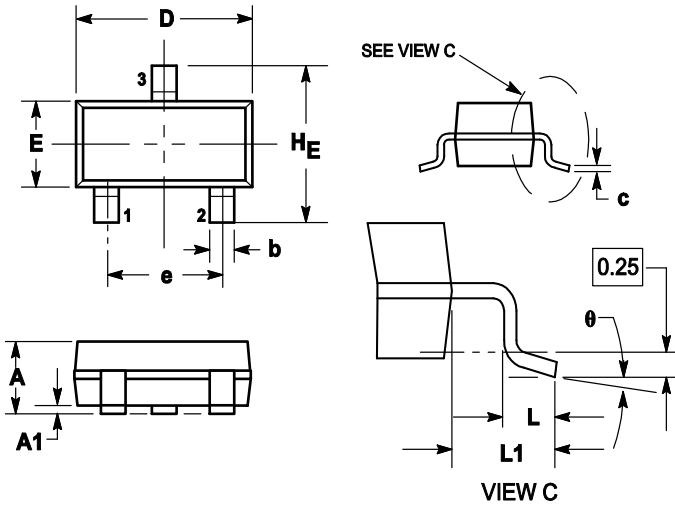

DIM	MILLIMETERS			INCHES		
	MIN	NOM	MAX	MIN	NOM	MAX
A	0.89	1	1.11	0.035	0.04	0.044
A1	0.01	0.06	0.1	0.001	0.002	0.004
b	0.37	0.44	0.5	0.015	0.018	0.02
c	0.09	0.13	0.18	0.003	0.005	0.007
D	2.80	2.9	3.04	0.11	0.114	0.12
E	1.20	1.3	1.4	0.047	0.051	0.055
e	1.78	1.9	2.04	0.07	0.075	0.081
L	0.10	0.2	0.3	0.004	0.008	0.012
L1	0.35	0.54	0.69	0.014	0.021	0.029
HE	2.10	2.4	2.64	0.083	0.094	0.104
theta	0°	---	10°	0°	---	10°

9. SOLDERING FOOTPRINT

