

N2308L

60V N-Channel Enhancement-Mode MOSFET

1. FEATURES

- VDS= 60V
- RDS(ON) \leq 100m Ω @VGS =10V
- RDS(ON) \leq 130m Ω @VGS =4.5V
- Super high density cell design for extremely low RDS(ON).
- Exceptional on-resistance and maximum DC current capability.
- We declare that the material of product compliance with RoHS requirements and Halogen Free.

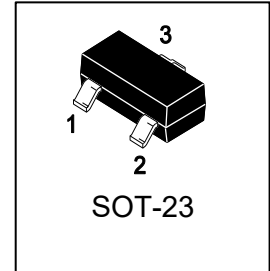

2. APPLICATIONS

- Power Management in Note book
- Portable Equipment
- Battery Powered System
- Load Switch
- DSC

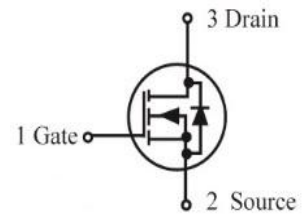

3. DEVICE MARKING AND ORDERING INFORMATION

Device	Marking	Shipping
N2308L	N08	3000/Tape&Reel

4. MAXIMUM RATINGS(Ta = 25°C)

Parameter	Symbol	Limits	Unit
Drain-Source Voltage	VDSS	60	V
Gate-Source Voltage	VGS	\pm 20	V
Continuous Drain Current(Tj=150°C)	ID	TA =25°C	2.6
		TA =70°C	1.8
Pulsed Drain Current	IDM	8	A
Maximum Body-Diode Continuous Current	IS	1.6	



5. THERMAL CHARACTERISTICS

Parameter		Symbol	Limits	Unit
Maximum Power Dissipation	TA =25°C	PD	0.7	W
	TA =70°C		0.45	
Operating Junction Temperature		TJ	150	°C
Maximum Junction-to-Ambient	T ≤10 sec	RθJA	150	°C/W
	Steady State		175	
Thermal Resistance-Junction to Case		RθJC	120	

1.The device mounted on 1in² FR4 board with 2 oz copper

6. ELECTRICAL CHARACTERISTICS (Ta= 25°C)

Characteristic	Symbol	Min.	Typ.	Max.	Unit	
STATIC						
Drain–Source Breakdown Voltage (VGS = 0, ID = 250μA)	V(BR)DSS	60	-	-	V	
Gate Threshold Voltage (VDS = VGS, ID = 250μA)	VGS(th)	1.0	-	3.0	V	
Gate Body Leakage (VDS =0V, VGS =±20V)	IGSS	-	-	±100	nA	
Zero Gate Voltage Drain Current (VDS =60V, VGS =0V)	IDSS	-	-	1	μA	
Drain-Source On-Resistance (VGS =10V, ID = 2.6A) (VGS =4.5V, ID = 2.1A)	RDS(on)	-	82 96	100 130	mΩ	
Diode Forward Voltage (IS =1.0A, VGS =0V)	VSD	-	0.8	1.2	V	
DYNAMIC						
Total Gate Charge (VDS =30V, VGS =10V, ID =2.6A)	Qg	-	12	-	nC	
Total Gate Charge	(VDS =30V, VGS =4.5V, ID =2.6A)	Qg	-	6.5		-
Gate-Source Charge	Qgs	-	2.2	-		
Gate-Drain Charge	Qgd	-	2.7	-		
Input capacitance	(VDS =30V, VGS =0V, f=1MHz)	Ciss	-	350	pF	
Output Capacitance		Coss	-	40		
Reverse Transfer Capacitance		Crss	-	12		
Gate Resistance (VDS =0V, VGS =0V, f=1MHz)	Rg	-	0.7	-	Ω	
Turn-On Delay Time	(VDD =20V, RL =20Ω, ID =1A, VGEN =10V, RG =1Ω)	td(on)	-	10	ns	
Turn-On Rise Time		tr	-	11		
Turn-Off Delay Time		td(off)	-	29		
Turn-Off Fall Time		tf	-	3		

2.Pulse test; pulse width ≤300μs, duty cycle ≤2%.

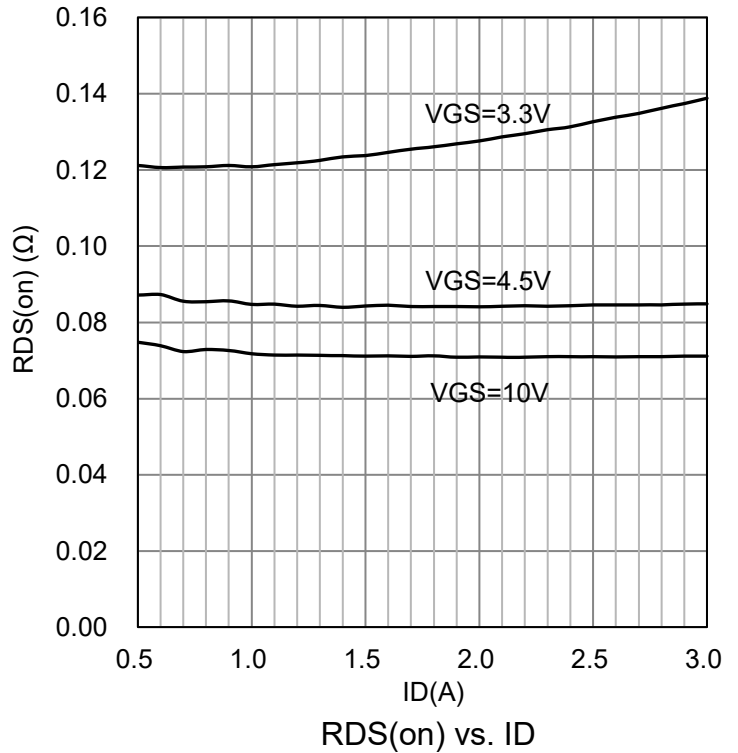
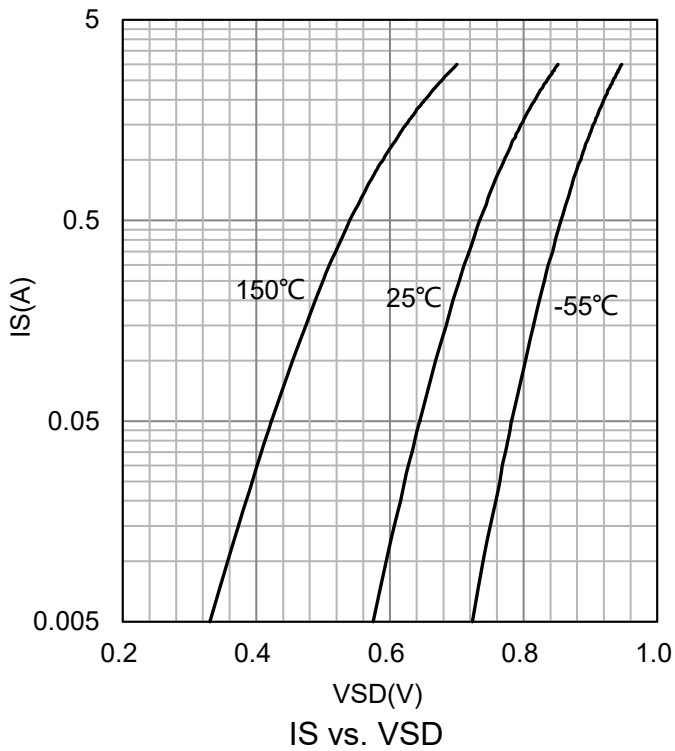
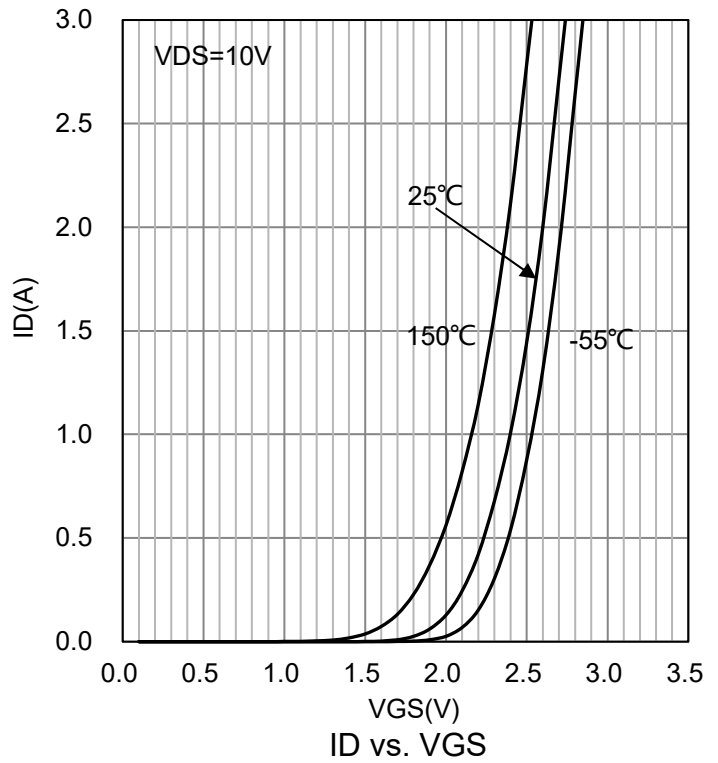
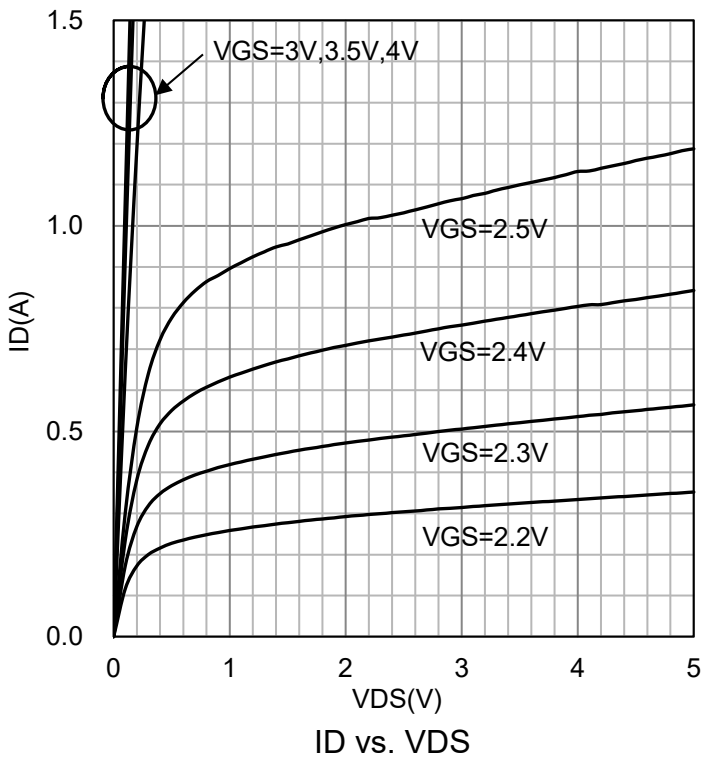

7.ELECTRICAL CHARACTERISTICS CURVES

7.ELECTRICAL CHARACTERISTICS CURVES (Con.)

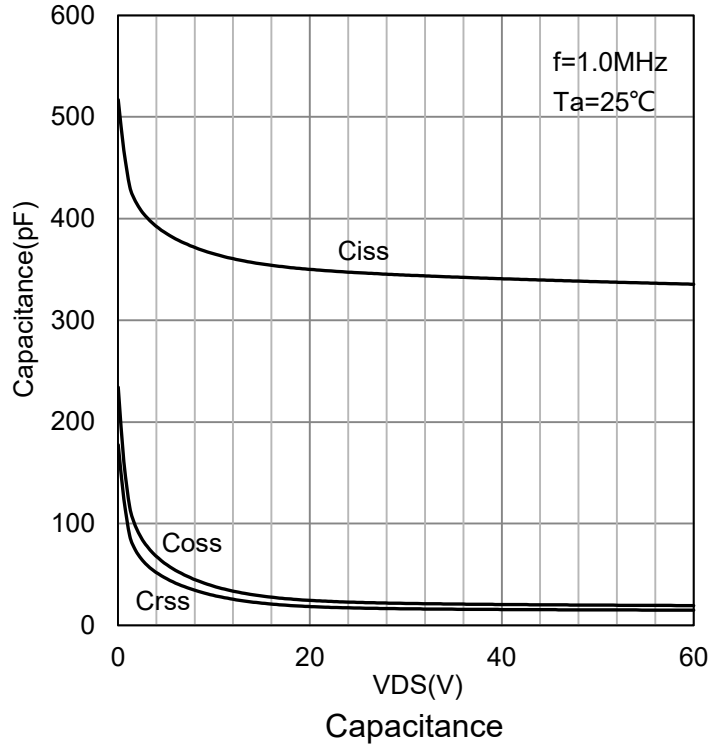
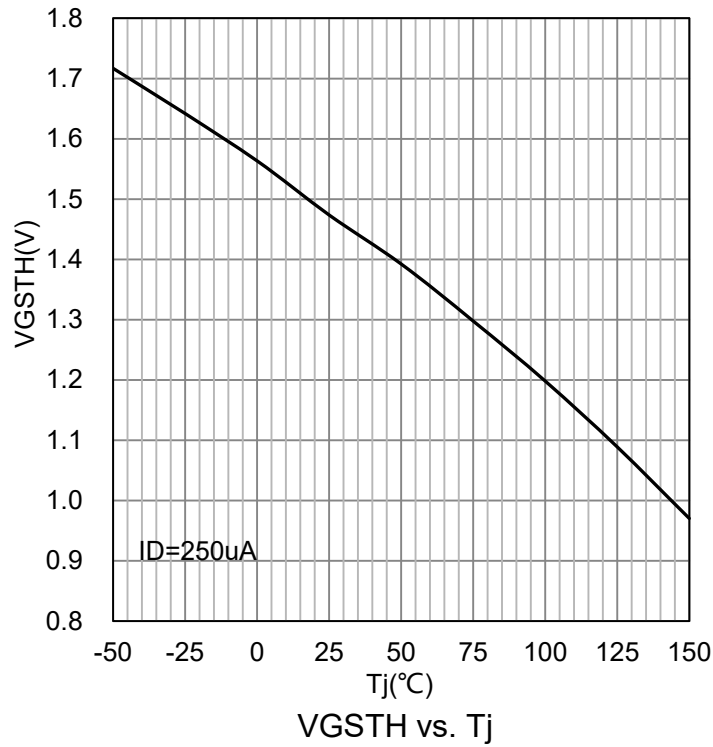
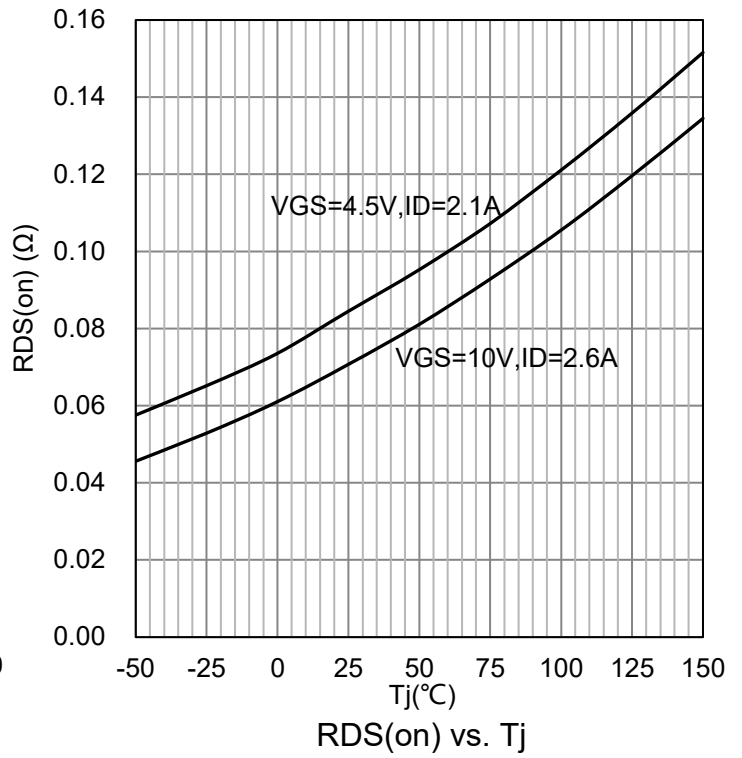
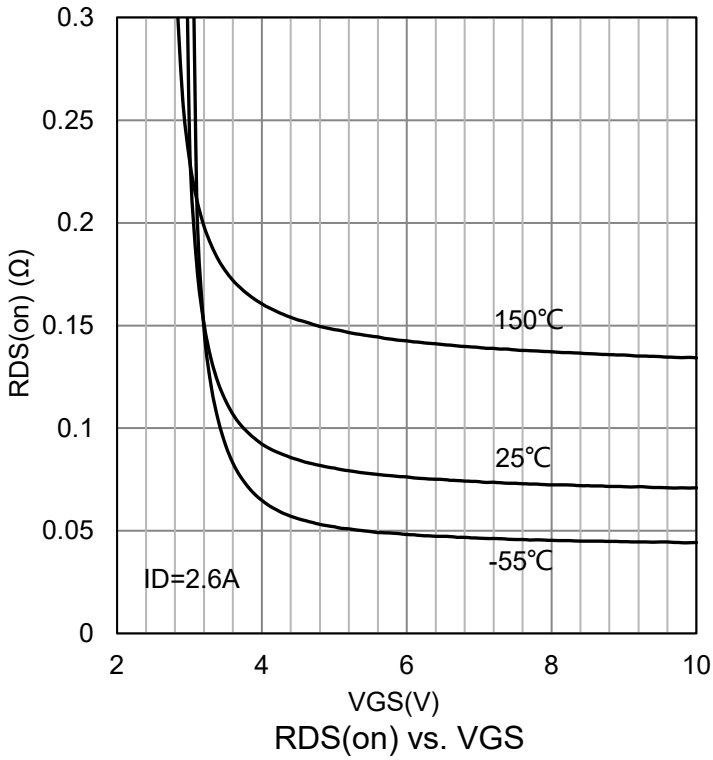

8.OUTLINE AND DIMENSIONS

Notes:

1. DIMENSIONING AND TOLERANCING PER ANSI Y14.5M, 1982.
2. CONTROLLING DIMENSION: MILLIMETERS.
3. MAXIMUM LEAD THICKNESS INCLUDES LEAD FINISH. MINIMUM LEAD THICKNESS IS THE MINIMUM THICKNESS OF BASE MATERIAL.
4. DIMENSIONS D AND E DO NOT INCLUDE MOLD FLASH, PROTRUSIONS OR GATE BURRS.

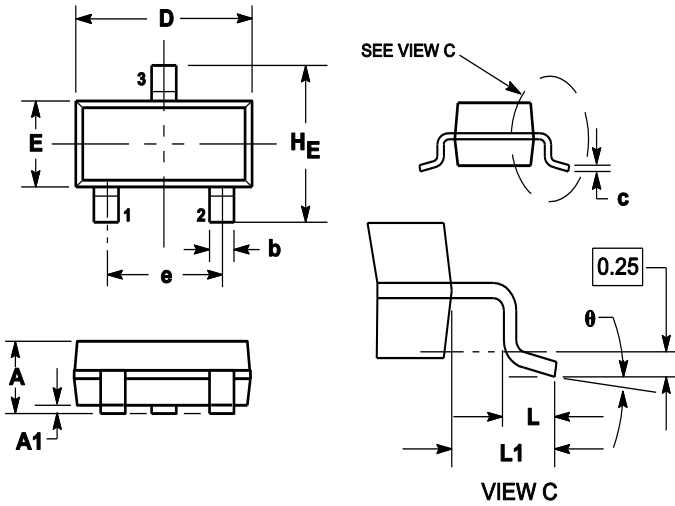

DIM	MILLIMETERS			INCHES		
	MIN	NOM	MAX	MIN	NOM	MAX
A	0.89	1	1.11	0.035	0.04	0.044
A1	0.01	0.06	0.1	0.001	0.002	0.004
b	0.37	0.44	0.5	0.015	0.018	0.02
c	0.09	0.13	0.18	0.003	0.005	0.007
D	2.80	2.9	3.04	0.11	0.114	0.12
E	1.20	1.3	1.4	0.047	0.051	0.055
e	1.78	1.9	2.04	0.07	0.075	0.081
L	0.10	0.2	0.3	0.004	0.008	0.012
L1	0.35	0.54	0.69	0.014	0.021	0.029
HE	2.10	2.4	2.64	0.083	0.094	0.104
θ	0°	---	10°	0°	---	10°

9.SOLDERING FOOTPRINT

