

N2302A

S-N2302A

20V N-Channel Enhancement-Mode MOSFET

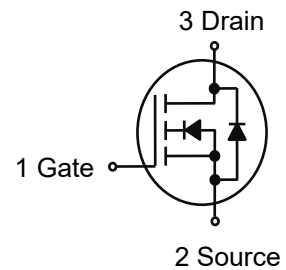
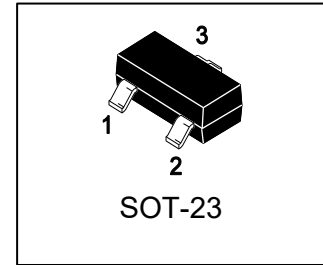

1. FEATURES

- Super high density cell design for extremely low RDS(ON)
- Exceptional on-resistance and maximum DC current capability.
- We declare that the material of product compliance with RoHS requirements and Halogen Free.
- S-prefix for automotive and other applications requiring unique site and control change requirements; AEC-Q101 qualified and PPAP capable.

2. APPLICATIONS

- Power Management in Notebook
- Portable Equipment
- Load Switch
- DSC

3. DEVICE MARKING AND ORDERING INFORMATION

Device	Marking	Shipping
N2302A	02A	3000/Tape&Reel

4. MAXIMUM RATINGS(Ta = 25°C)

Parameter	Symbol	Limits	Unit
Drain-Source Voltage	VDSS	20	V
Gate-to-Source Voltage – Continuous	VGS	±8	V
Drain Current			
– Continuous TA = 25°C	ID	2.8	A
TA = 70°C		2.2	
– Pulsed	IDM	10	A
Maximum Body-Diode Continuous Current	IS	1.6	A

5. THERMAL CHARACTERISTICS

Parameter	Symbol	Limits	Unit
Maximum Power Dissipation	PD	TA =25°C	1.25
		TA =70°C	0.8
Thermal Resistance, Junction-to-Ambient	RθJA	T ≤ 10 s	77
		Steady State	105
Thermal Resistance, Junction-to-Case	RθJC	70	°C/W
Junction and Storage temperature	TJ, Tstg	-55~+150	°C

1. The device mounted on 1in² FR4 board with 2 oz copper



6. ELECTRICAL CHARACTERISTICS (Ta= 25°C)

Characteristic	Symbol	Min.	Typ.	Max.	Unit	
Drain–Source Breakdown Voltage (VGS = 0, ID = 250μA)	V(BR)DSS	20	-	-	V	
Gate Threshold Voltage (VDS = VGS, ID = 250μA)	VGS(th)	0.6	0.9	1.2	V	
Zero Gate Voltage Drain Current (VDS=20V, VGS=0V) (VDS=20V, VGS=0V, TJ =55°C)	IDSS	-	-	1 10	μA	
Gate–Body Leakage Current (VDS = 0 V, VGS = ±8 V)	IGSS	-	-	±100	nA	
Static Drain–Source On–State Resistance (VGS =4.5V, ID = 2.8A) (VGS =2.5V, ID = 2.5A) (VGS =1.8V, ID = 2.2A)	RDS(on)	-	55 65 80	85 115 130	mΩ	
Forward Voltage (IS =1A, VGS =0V)	VSD	-	0.75	1.2	V	
Input Capacitance (VGS = 0 V, f = 1.0MHz, VDS= 10 V)	Ciss	-	311	-	pF	
Output Capacitance (VGS = 0 V, f = 1.0MHz, VDS= 10 V)	Coss	-	33	-	pF	
Reverse Transfer Capacitance (VGS = 0 V, f = 1.0MHz, VDS= 10 V)	Crss	-	26.3	-	pF	
Total Gate Charge	(VDS =10V, VGS =4.5V, ID =2.8A)	Qg	-	3.1	-	nC
Gate–Source Charge		Qgs	-	0.5	-	
Gate–Drain Charge		Qgd	-	0.7	-	
Turn-On Delay Time	(VDD = 10V, VGEN = 4.5V,RL = 10 Ω ,RG = 6.2Ω)	td(on)	-	3.4	-	ns
Rise Time		tr	-	2.1	-	
Turn-Off Delay Time		td(off)	-	12.5	-	
Fall Time		tf	-	2.3	-	

2.Pulse Test: Pulse Width ≤300 μs, Duty Cycle ≤2.0%.

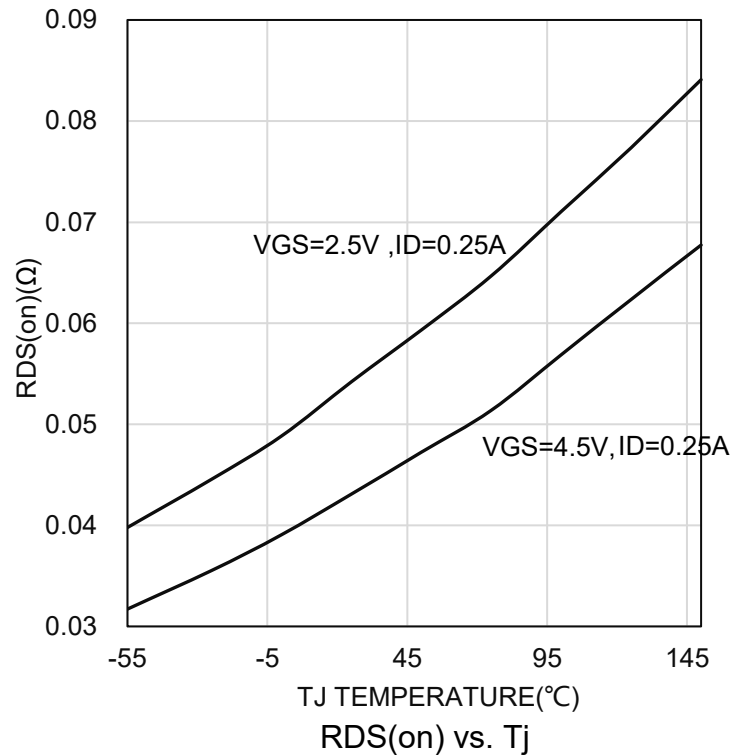
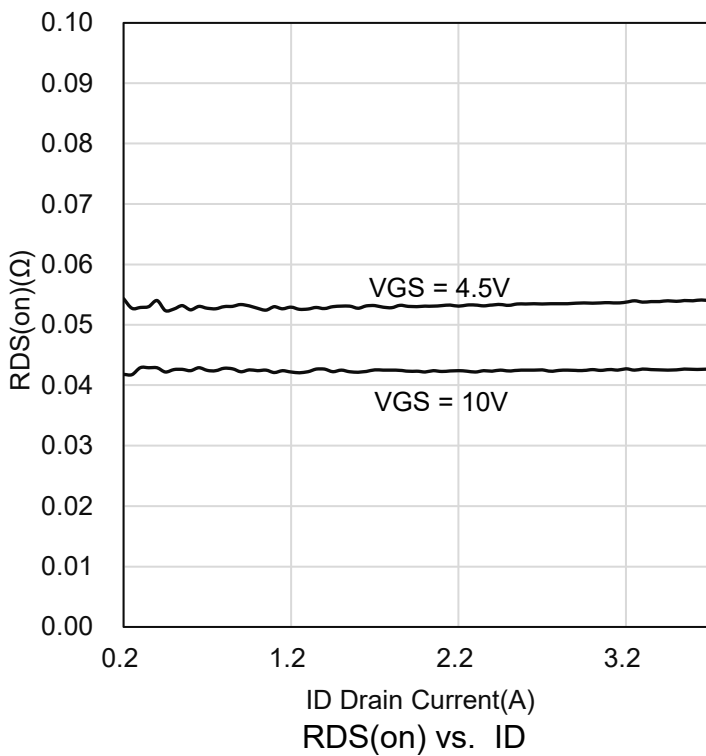
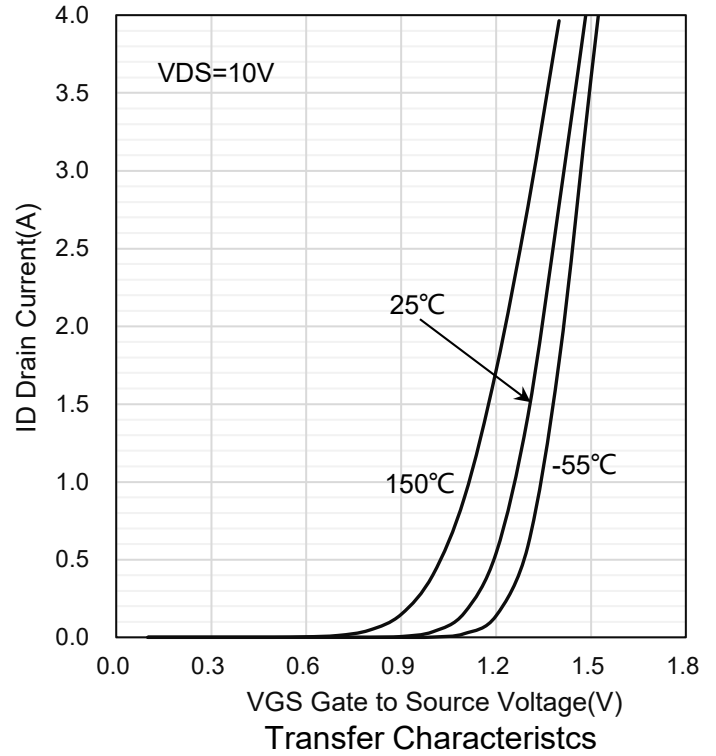
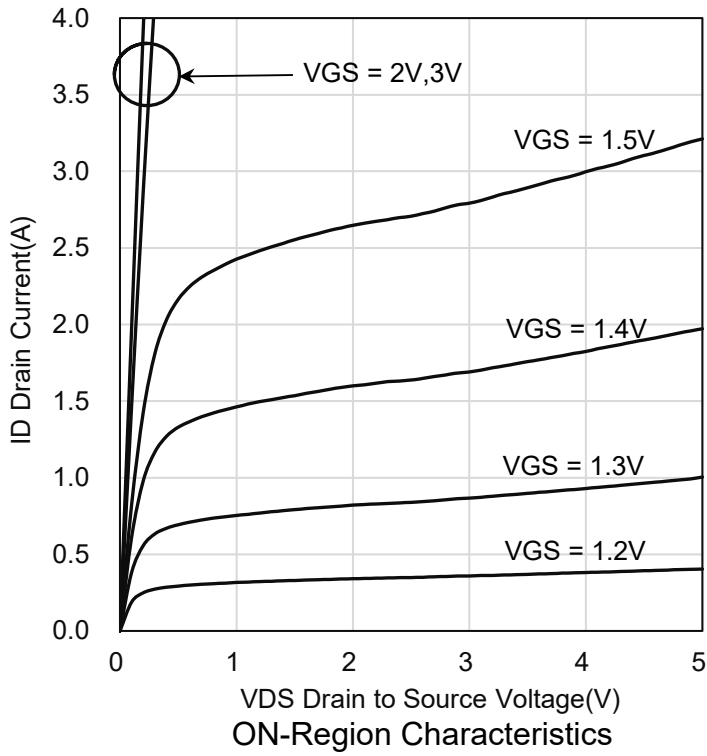

7. ELECTRICAL CHARACTERISTICS CURVES

7. ELECTRICAL CHARACTERISTICS CURVES(Con.)

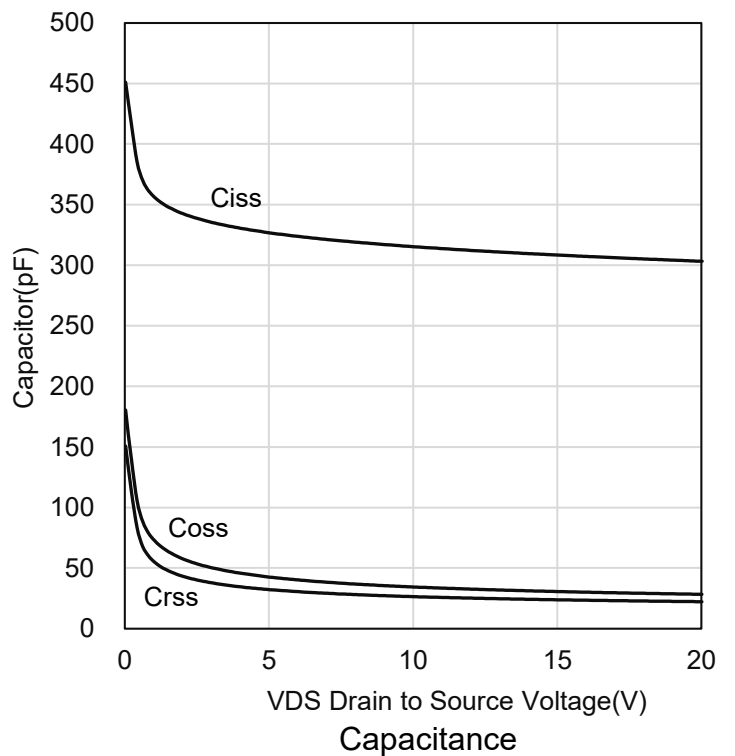
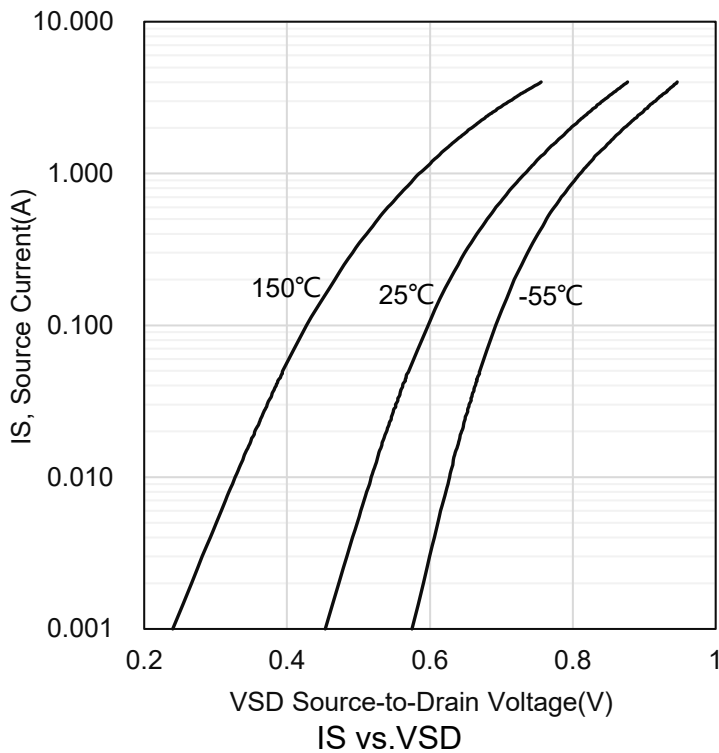
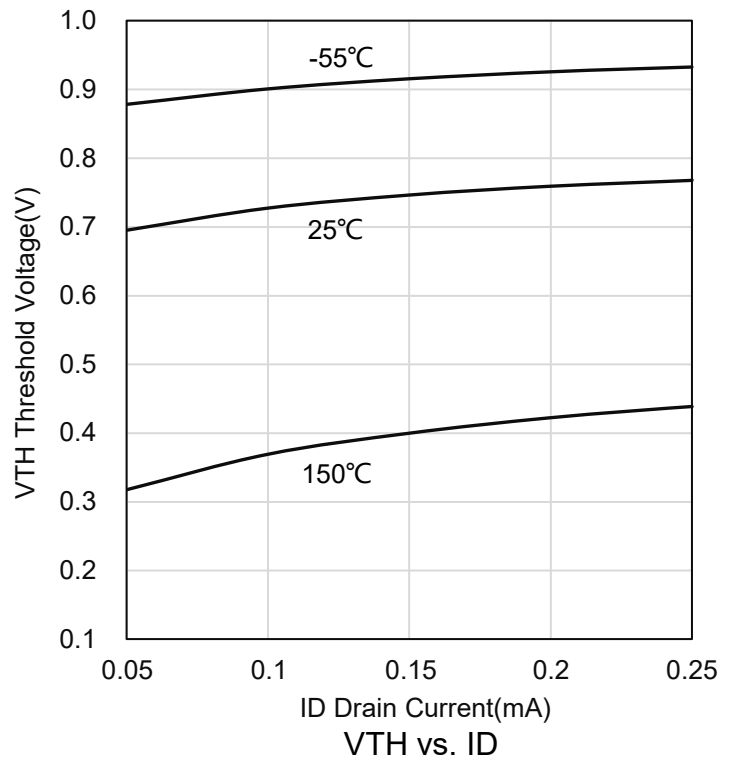
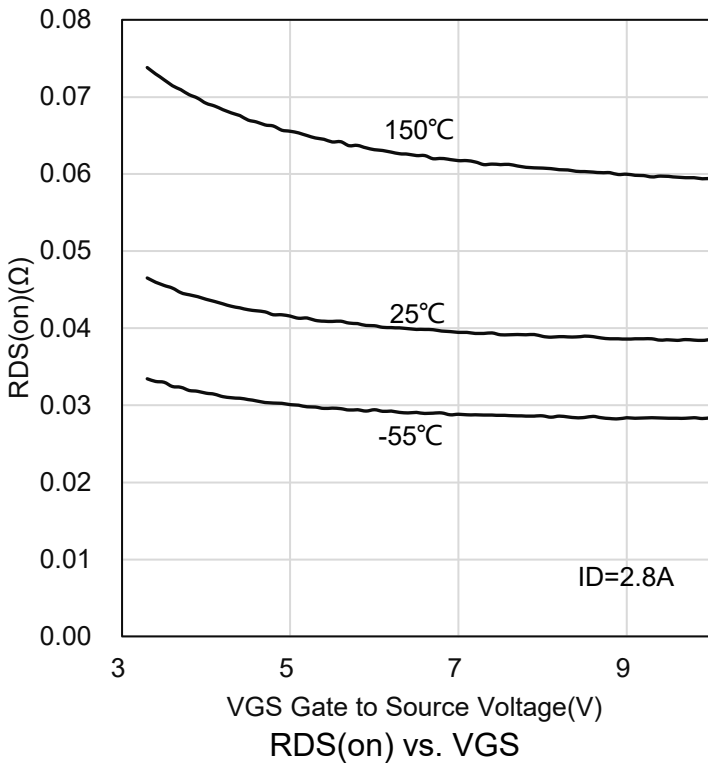

8. OUTLINE AND DIMENSIONS

Notes:

1. DIMENSIONING AND TOLERANCING PER ANSI Y14.5M, 1982.
2. CONTROLLING DIMENSION: MILLIMETERS.
3. MAXIMUM LEAD THICKNESS INCLUDES LEAD FINISH. MINIMUM LEAD THICKNESS IS THE MINIMUM THICKNESS OF BASE MATERIAL.
4. DIMENSIONS D AND E DO NOT INCLUDE MOLD FLASH, PROTRUSIONS OR GATE BURRS.

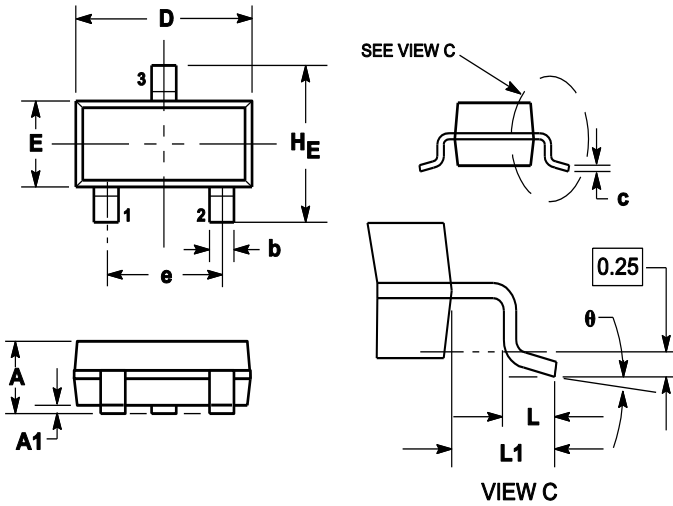

DIM	MILLIMETERS			INCHES		
	MIN	NOM	MAX	MIN	NOM	MAX
A	0.89	1	1.11	0.035	0.04	0.044
A1	0.01	0.06	0.1	0.001	0.002	0.004
b	0.37	0.44	0.5	0.015	0.018	0.02
c	0.09	0.13	0.18	0.003	0.005	0.007
D	2.80	2.9	3.04	0.11	0.114	0.12
E	1.20	1.3	1.4	0.047	0.051	0.055
e	1.78	1.9	2.04	0.07	0.075	0.081
L	0.10	0.2	0.3	0.004	0.008	0.012
L1	0.35	0.54	0.69	0.014	0.021	0.029
HE	2.10	2.4	2.64	0.083	0.094	0.104
θ	0°	---	10°	0°	---	10°

9. SOLDERING FOOTPRINT
