

DN2367

N-Channel Enhancement Mode Power MOSFET

1. FEATURES

- $V_{DS} = 20V, I_D = 6A$
- $R_{DS(ON)}, V_{GS}@4.5V, I_{DS}@4.5A = 20m\Omega$
- $R_{DS(ON)}, V_{GS}@2.5V, I_{DS}@3.5A = 25m\Omega$
- We declare that the material of product compliance with RoHS requirements and Halogen Free.
- S- prefix for automotive and other applications requiring unique site and control change requirements; AEC-Q101 qualified and PPAP capable.
- High power and current handling capability
- Lead free product is acquired
- Surface mount package

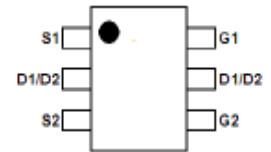
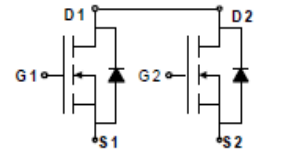
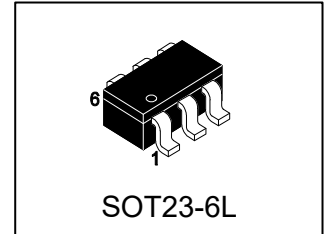

2. APPLICATIONS

- Battery protection
- Load switch
- Power management

3. DEVICE MARKING AND ORDERING INFORMATION

Device	Marking	Shipping
DN2367	206	3000/Tape&Reel
S-DN2367	206	3000/Tape&Reel

4. Absolute Maximum Ratings (TA =25 °C unless otherwise noted)

Parameter	Symbol	Limits	Unit
Drain-Source Voltage	V_{DS}	20	V
Gate-Source Voltage	V_{GS}	± 12	V
Drain Current-Continuous	I_D	6.3	A
Drain Current-Pulsed (Note1)	I_{DM}	25	A
Maximum Power Dissipation	P_D	1.5	W
Operating Junction and Storage Temperature Range	T_J, T_{STG}	-55 ~ +150	°C

Note:1. Repetitive Rating: Pulse width limited by maximum junction temperature.

5. THERMAL CHARACTERISTICS

Parameter	Symbol	Limits	Unit
Thermal Resistance, Junction-to-Ambient (Note 2)	$R_{\theta JA}$	83	°C/W

Note:2. Surface Mounted on FR4 Board, $t \leq 10$ sec.



6. ELECTRICAL CHARACTERISTICS (Ta= 25°C)

Parameter	Symbol	Min.	Typ.	Max.	Unit
Off Characteristics					
Drain-Source Breakdown Voltage (VGS =0V ID =250μA)	BVDSS	20	-	-	V
Zero Gate Voltage Drain Current (VDS =20V,VGS =0V)	IDSS	-	-	1	μA
Gate-Body Leakage Current (VGS =±12V,VDS =0V)	IGSS	-	-	±100	nA
On Characteristics (Note 3)					
Gate Threshold Voltage (VDS =V GS ,ID =250μA)	VGS(th)	0.5	0.7	1.2	V
Drain-Source On-State Resistance (VGS =4.5V, ID =4.5A)	RDS(ON)	-	16	22	mΩ
(VGS =2.5V, ID =3.5A)		-	19	27	mΩ
(VGS =4.5 V, ID =6A)		-	-	25	mΩ
(VGS =2.5V, ID =5A)		-	-	32	mΩ
(VGS =1.8V, ID =1A)		-	-	47	mΩ
Forward Transconductance (VDS =5V,ID =4.5A)	gFS	-	10	-	S
Dynamic Characteristics (Note4)					
Input Capacitance (VDS =10V,VGS =0V,F=1.0MHz)	Ciss	-	900	-	PF
Output Capacitance (VDS =10V,VGS =0V,F=1.0MHz)	Coss	-	220	-	PF
Reverse Transfer Capacitance (VDS =10V,VGS =0V,F=1.0MHz)	Crss	-	100	-	PF
Gate-Resistance (VGS = 0 V, VDS=0V,f=1MHz)	Rg	-	1.9	-	Ω
Switching Characteristics (Note 4)					
Turn-on Delay Time (VDD =10V,ID =1A VGS =4.5V,RGEN =6Ω)	td(on)	-	10	20	nS
Turn-on Rise Time (VDD =10V,ID =1A VGS =4.5V,RGEN =6Ω)	tr	-	11	25	nS
Turn-Off Delay Time (VDD =10V,ID =1A VGS =4.5V,RGEN =6Ω)	td(off)	-	35	70	nS
Turn-Off Fall Time (VDD =10V,ID =1A VGS =4.5V,RGEN =6Ω)	tf	-	30	60	nS
Total Gate Charge (VDS =10V,ID =6A, VGS =4.5V)	Qg	-	12	15	nC
Gate-Source Charge (VDS =10V,ID =6A, VGS =4.5V)	Qgs	-	2.3	-	nC
Gate-Drain Charge (VDS =10V,ID =6A, VGS =4.5V)	Qgd	-	1	-	nC



6. ELECTRICAL CHARACTERISTICS (Con.)(Ta= 25°C)

Drain-Source Diode Characteristics					
Turn-On Delay Time (VGS =0V,IS =1.0A)	VSD	-	0.75	1.5	V
Diode Forward Current (Note2)	IS	-	-	1.0	A

Note: 3. Pulse Test: Pulse Width \leq 300 μ s, Duty Cycle \leq 2%.

4. Guaranteed by design, not subject to production



7. ELECTRICAL CHARACTERISTICS CURVES

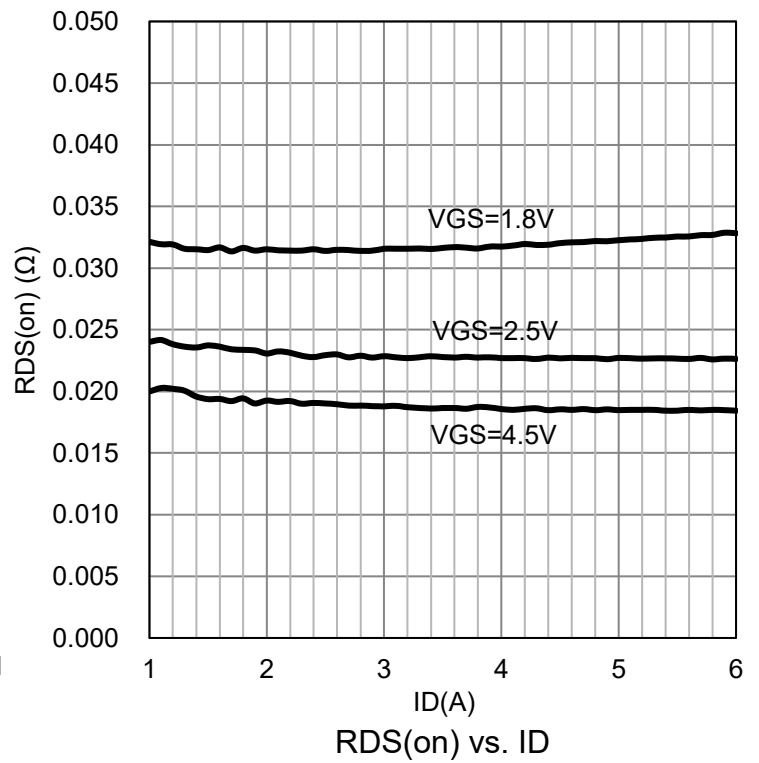
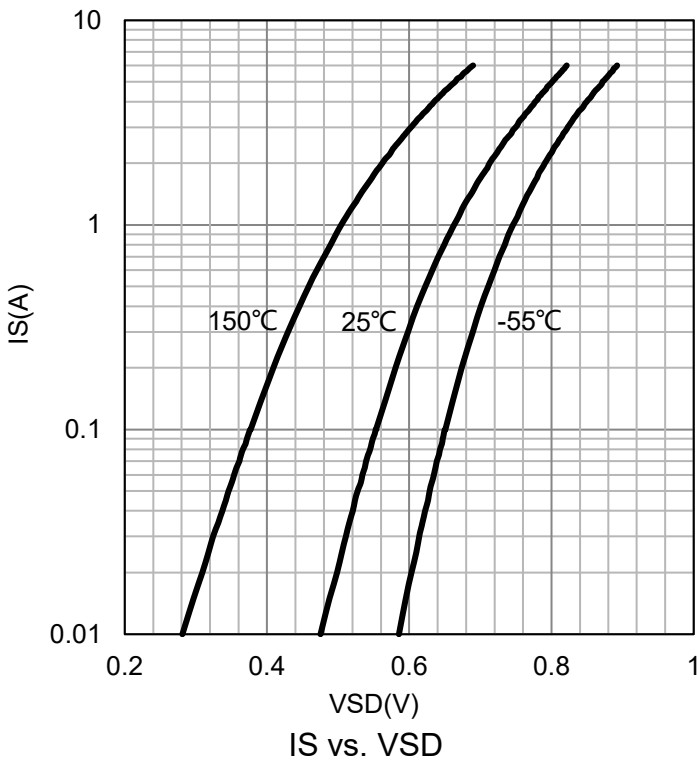
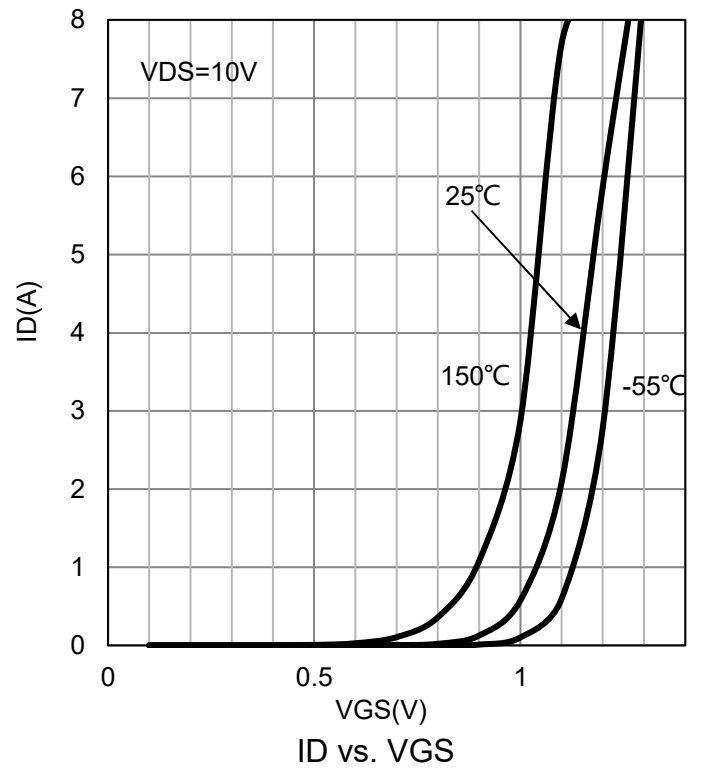
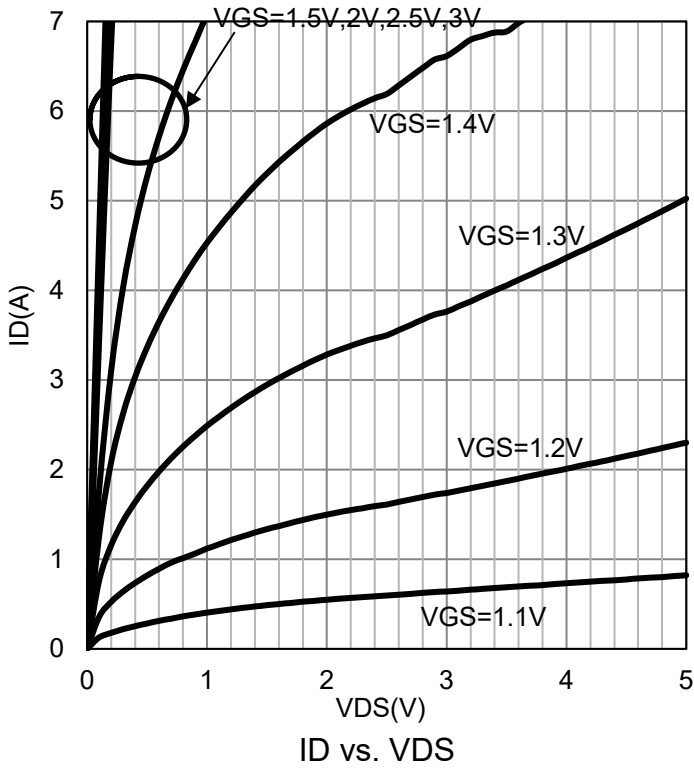

7.ELECTRICAL CHARACTERISTICS CURVES (Con.)

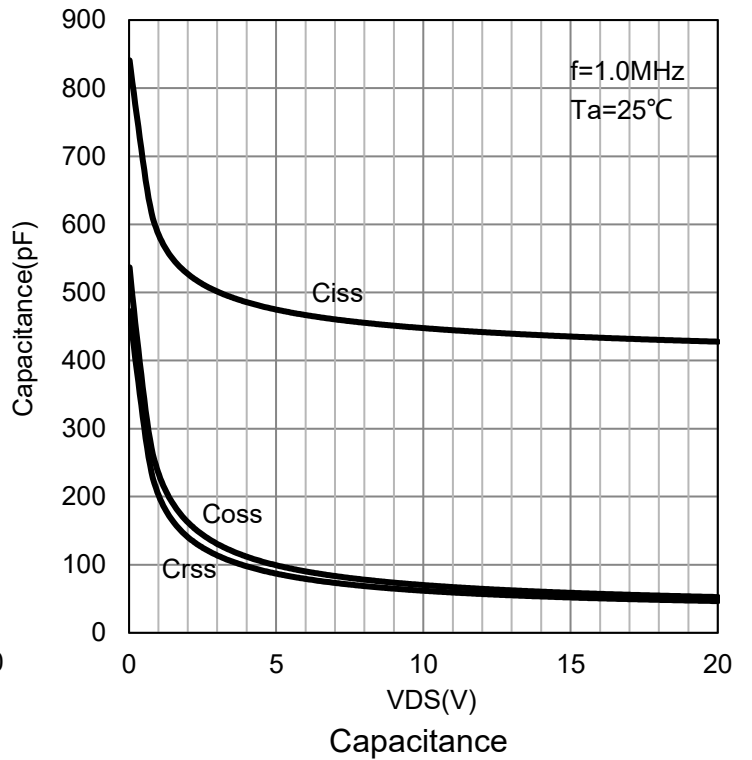
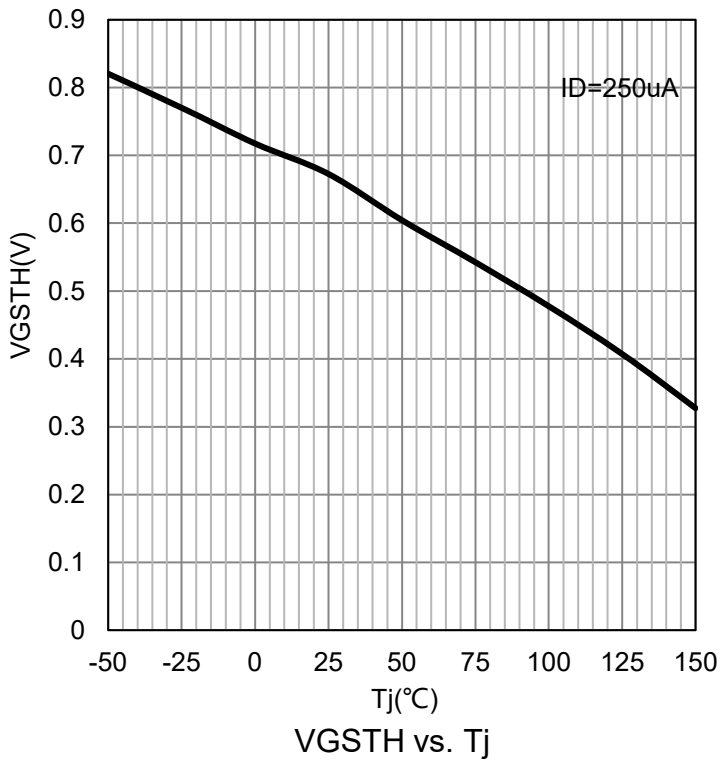
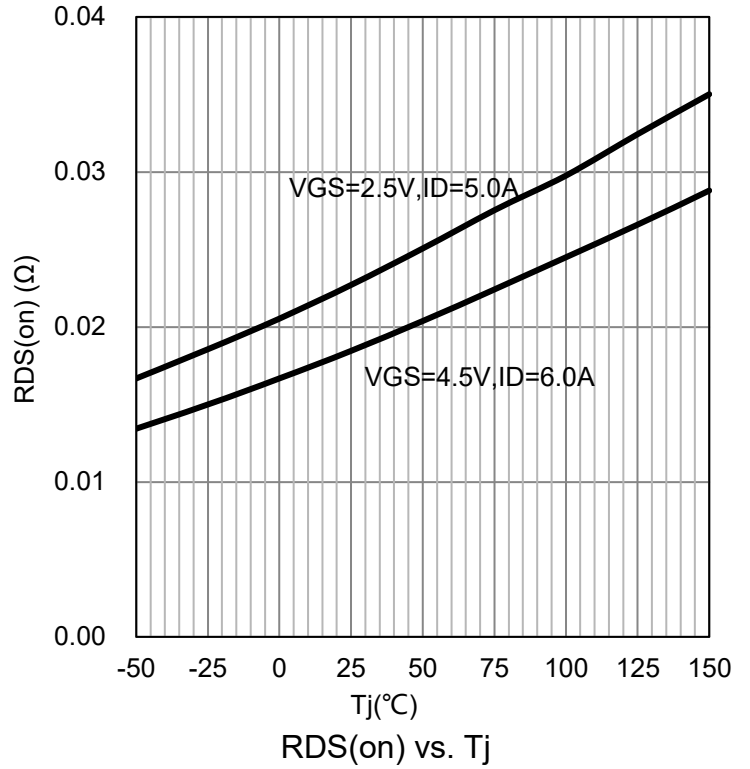
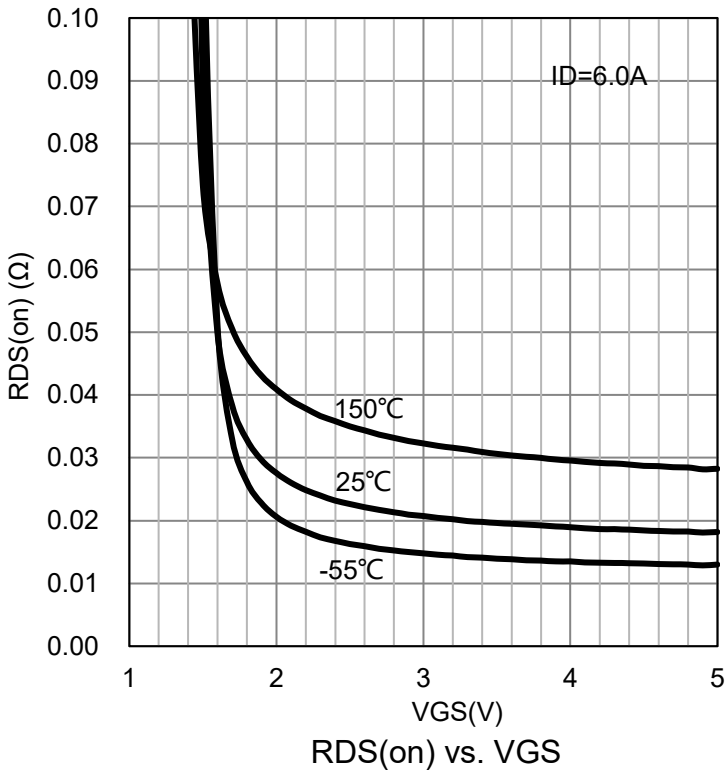

7.ELECTRICAL CHARACTERISTICS CURVES (Con.)

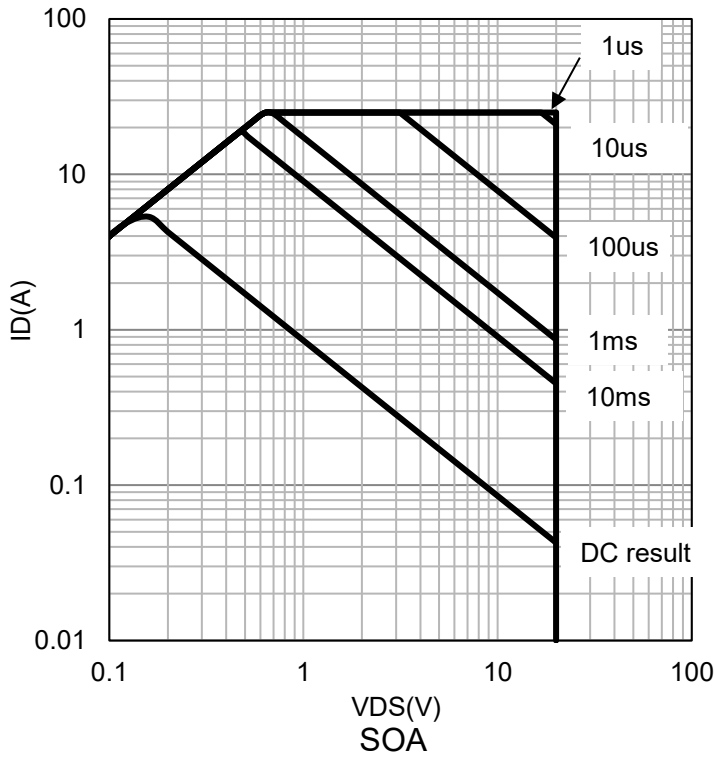

8.OUTLINE AND DIMENSIONS

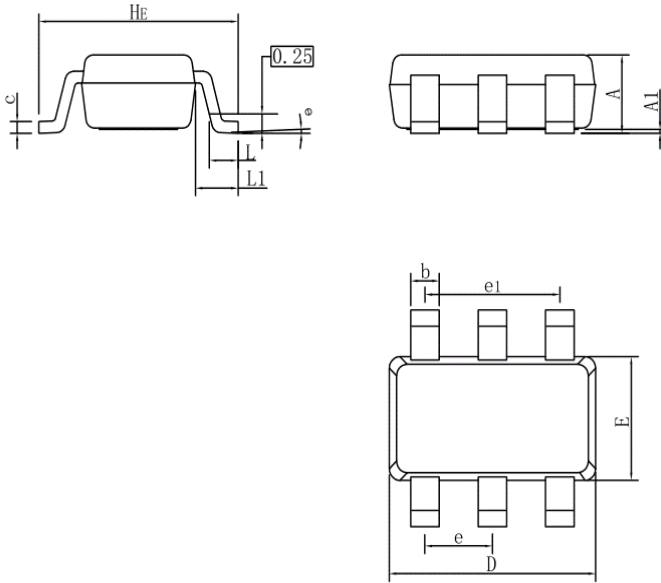

SOT23-6L			
DIM	MIN	NOR	MAX
A	0.90	1.00	1.10
A1	0.01	0.06	0.10
b	0.30	0.40	0.50
c	0.10	0.17	0.20
D	2.80	2.90	3.00
E	1.50	1.60	1.70
e	0.85	0.95	1.05
e1	1.80	1.90	2.00
L	0.20	0.40	0.60
L1	0.60REF		
HE	2.60	2.80	3.00
θ	0°	-	10°

9.SOLDERING FOOTPRINT

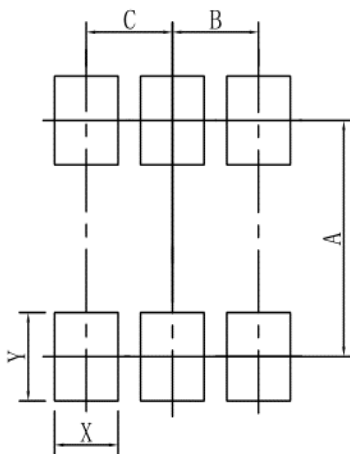

SOT23-6L	
DIM	(mm)
X	0.70
Y	0.90
A	2.40
B	0.95
C	0.95

