

# BSS138L

## S-BSS138L

Power MOSFET

200 mAmps, 50 Volts N-Channel SOT-23

### 1. FEATURES

- We declare that the material of product compliance with RoHS requirements and Halogen Free.
- S- prefix for automotive and other applications requiring unique site and control change requirements; AEC-Q101 qualified and PPAP capable.
- Low threshold voltage ( $V_{GS(th)}$ : 0.5V...1.5V) makes it ideal for low voltage applications.

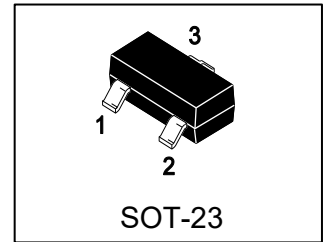

### 2. DEVICE MARKING AND ORDERING INFORMATION

Device	Marking	Shipping
BSS138L	J1	3000/Tape&Reel

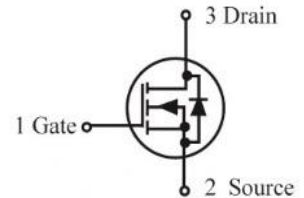

### 3. MAXIMUM RATINGS( $T_a = 25^\circ\text{C}$ )

Parameter	Symbol	Limits	Unit
Drain-Source Voltage	VDSS	50	Vdc
Gate-to-Source Voltage – Continuous	VGS	$\pm 20$	Vdc
Drain Current			mAdc
– Continuous $T_A = 25^\circ\text{C}$	ID	200	
– Pulsed ( $t_p \leq 10\mu\text{s}$ )	IDM	800	

### 4. THERMAL CHARACTERISTICS

Parameter	Symbol	Limits	Unit
Total Device Dissipation, FR-5 Board (Note 1) @ $T_A = 25^\circ\text{C}$ Derate above $25^\circ\text{C}$	PD	225 1.8	mW mW/ $^\circ\text{C}$
Thermal Resistance, Junction-to-Ambient(Note 1)	$R_{\theta JA}$	556	$^\circ\text{C}/\text{W}$
Junction and Storage temperature	$T_J, T_{stg}$	$-55 \sim +150$	$^\circ\text{C}$
Maximum Lead Temperature for Solde Purposes, for 10 seconds	TL	260	$^\circ\text{C}$

1. FR-5 = 1.0x0.75x0.062 in.



## 5. ELECTRICAL CHARACTERISTICS (Ta= 25°C)

### OFF CHARACTERISTICS

Characteristic	Symbol	Min.	Typ.	Max.	Unit
Drain–Source Breakdown Voltage (VGS = 0, ID = 250μAdc)	VBRDSS	50	-	-	Vdc
Zero Gate Voltage Drain Current (VGS = 0, VDS = 25 Vdc) (VGS = 0, VDS = 50 Vdc)	IDSS	-	-	0.1 0.5	μAdc
Gate–Body Leakage Current, Forward (VGS = 20 Vdc)	IGSSF	-	-	0.1	μAdc
Gate–Body Leakage Current, Reverse (VGS = - 20 Vdc)	IGSSR	-	-	-0.1	μAdc

### ON CHARACTERISTICS (Note 2)

Gate Threshold Voltage (VDS = VGS, ID = 1.0mAdc)	VGS(th)	0.5	-	1.5	Vdc
Static Drain–Source On–State Resistance (VGS = 2.75 Vdc, ID < 200 mAdc, TA = -40°C to +85°C) (VGS = 5.0 Vdc, ID = 200 mAdc)	RDS(on)	-	5.6	10 3.5	Ohms
Forward Transconductance (VDS = 25 Vdc, ID = 200 mAdc, f = 1.0 kHz)	gfs	100	-	-	mS

### DYNAMIC CHARACTERISTICS

Input Capacitance (VDS = 25 Vdc, VGS = 0, f = 1.0 MHz)	Ciss	-	40	50	pF
Output Capacitance (VDS = 25 Vdc, VGS = 0, f = 1.0 MHz)	Coss	-	12	25	pF
Reverse Transfer Capacitance (VDS = 25 Vdc, VGS = 0, f = 1.0 MHz)	Ciss	-	3.5	5.0	pF

### SWITCHING CHARACTERISTICS

Turn-On Delay Time	(VDD = 30 Vdc , ID =200 mAdc)	td(on)	-	-	20	ns
Turn-Off Delay Time		td(off)	-	-	20	

2.Pulse Test: Pulse Width  $\leq 300 \mu s$ , Duty Cycle  $\leq 2.0\%$ .



## 6. ELECTRICAL CHARACTERISTICS CURVES

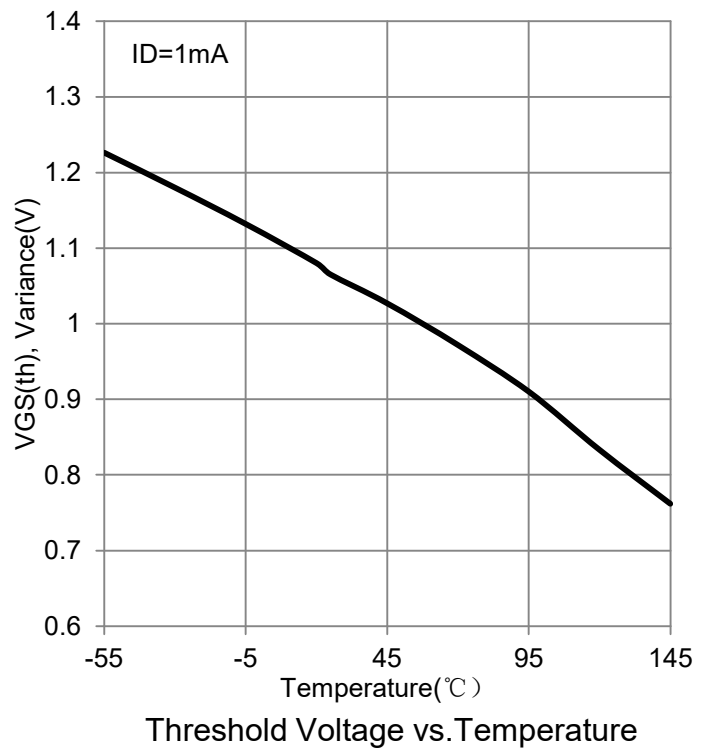
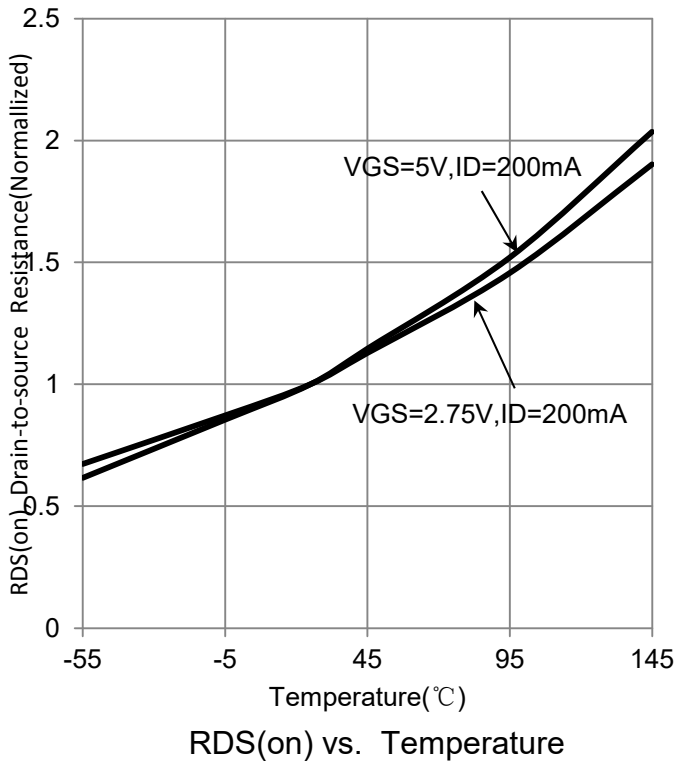
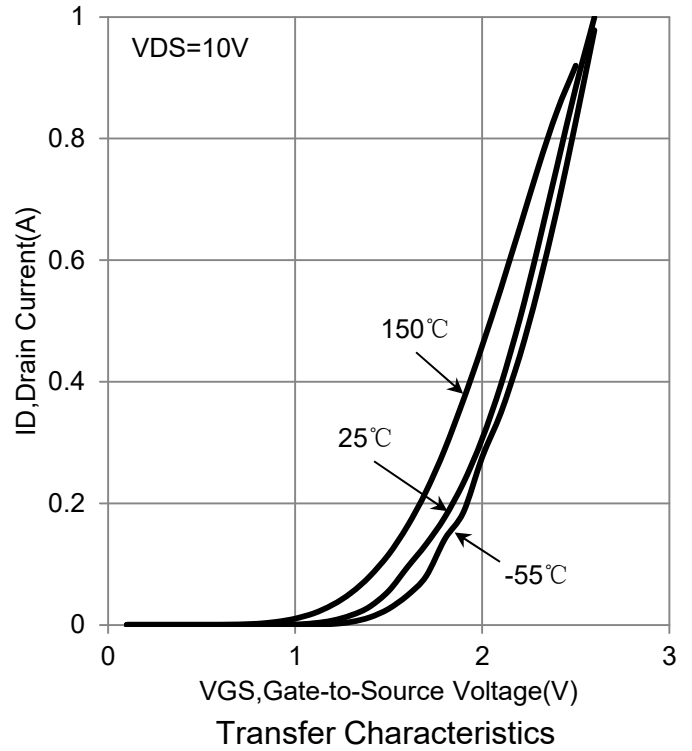
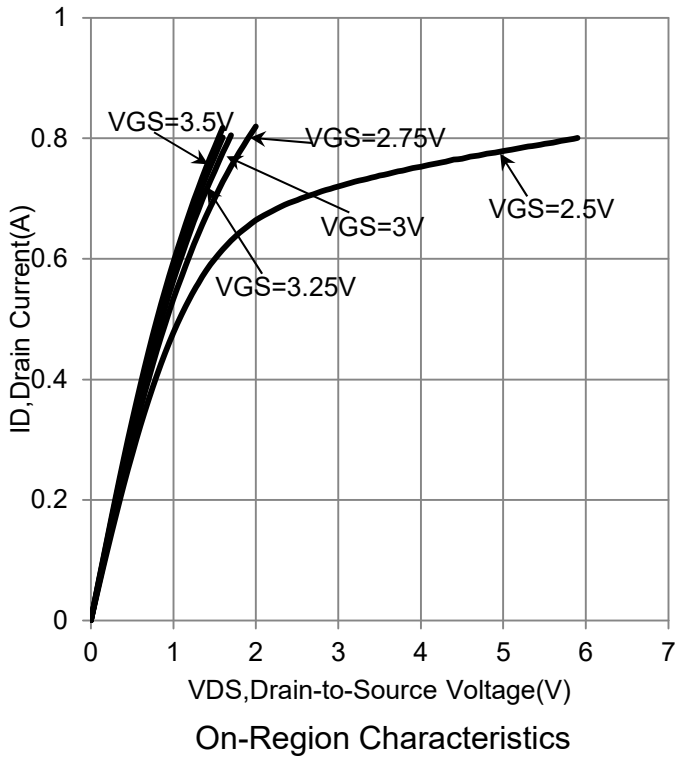

## 6.ELECTRICAL CHARACTERISTICS CURVES(Con.)

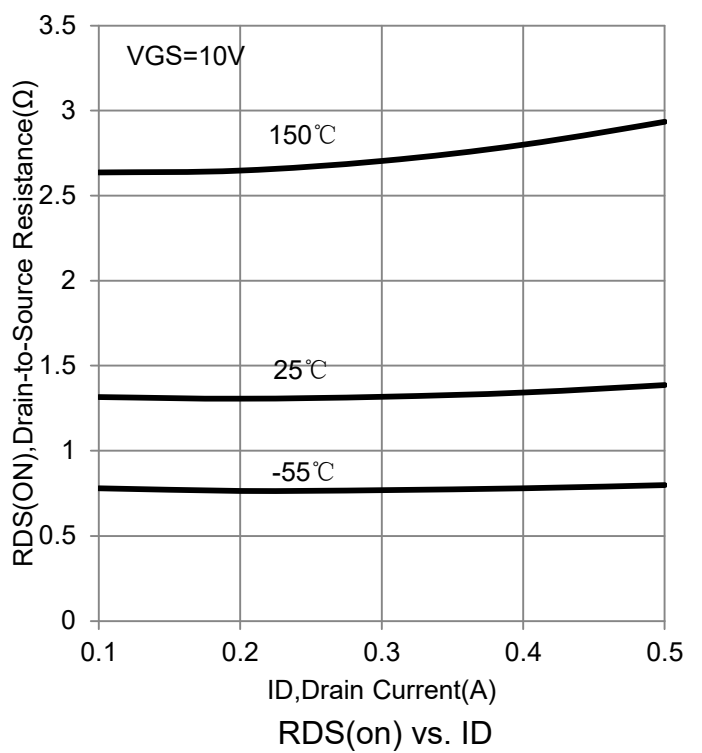
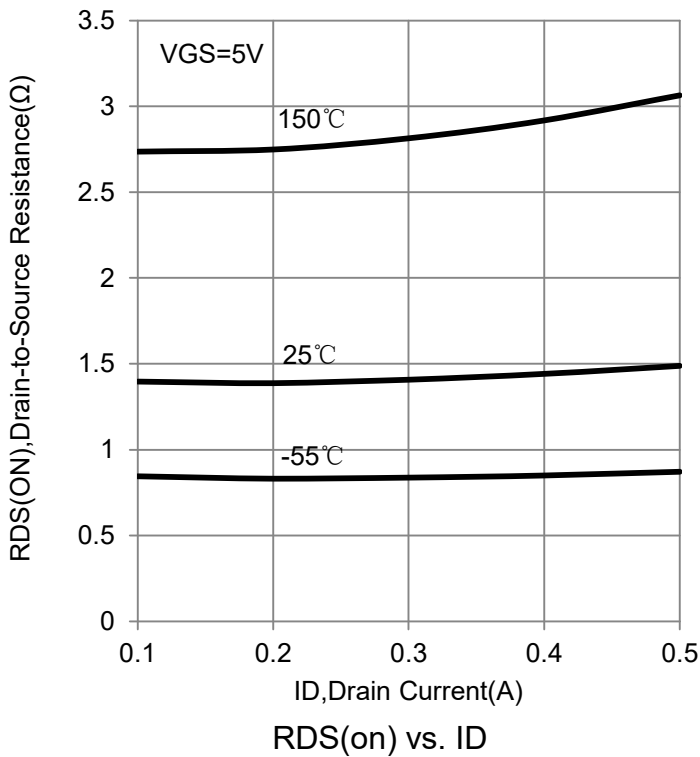
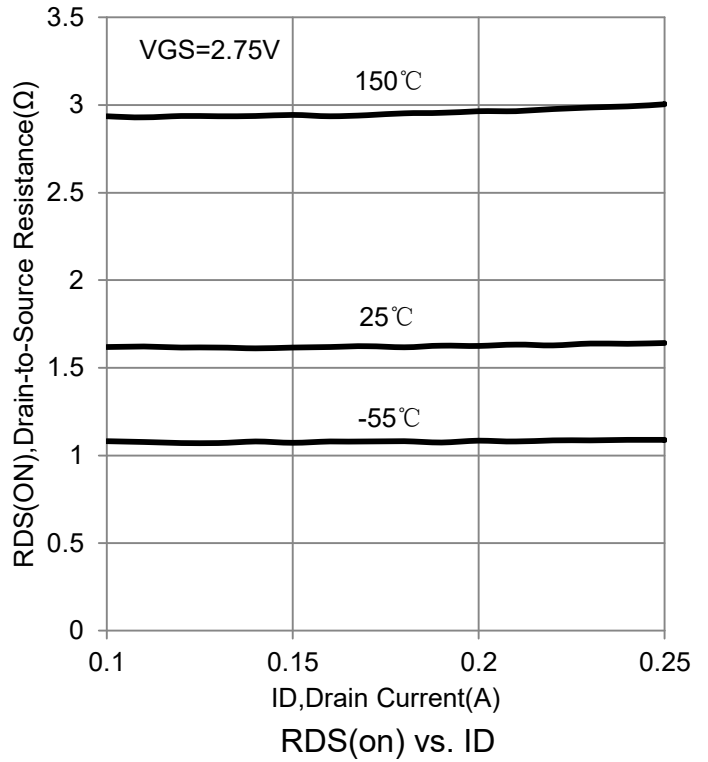
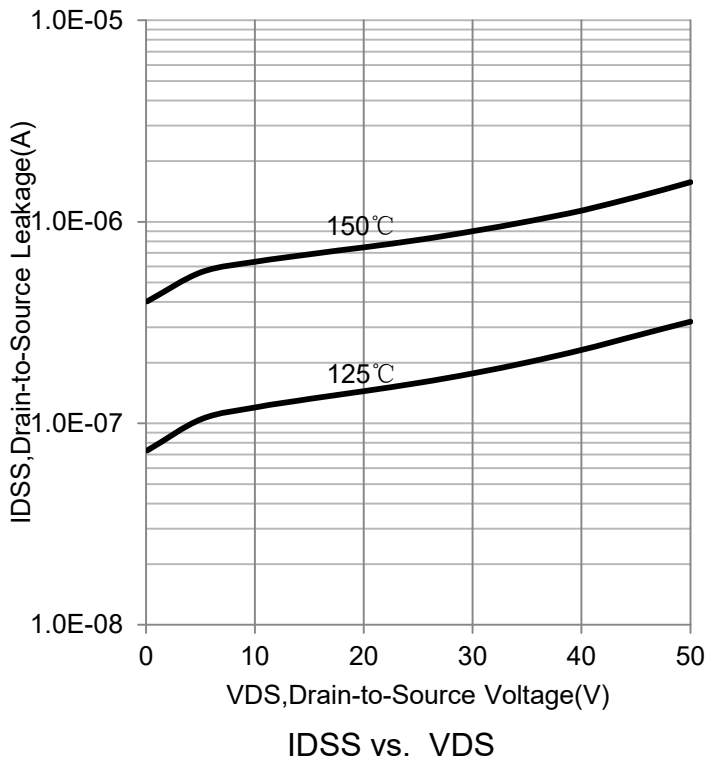

**6.ELECTRICAL CHARACTERISTICS CURVES(Con.)**

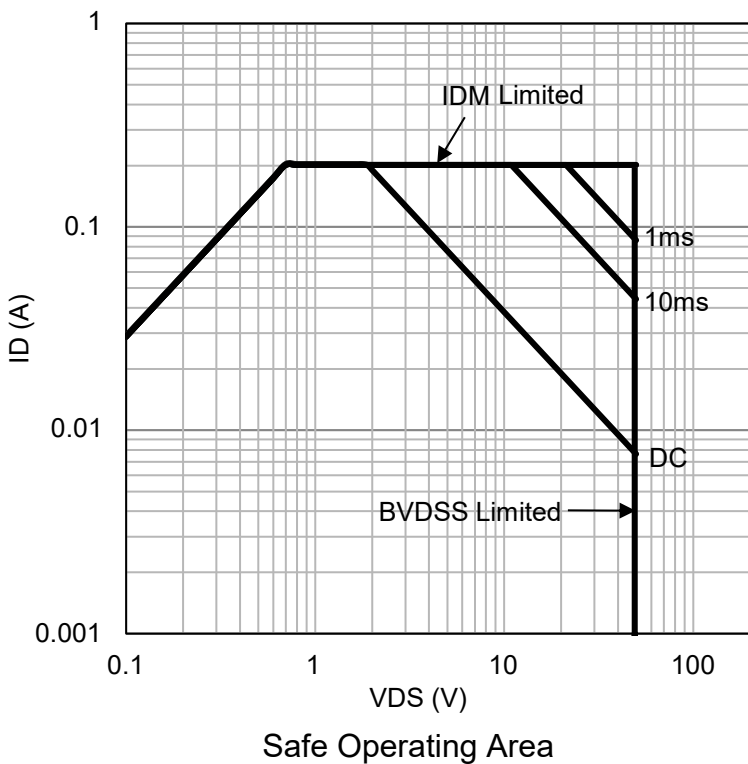
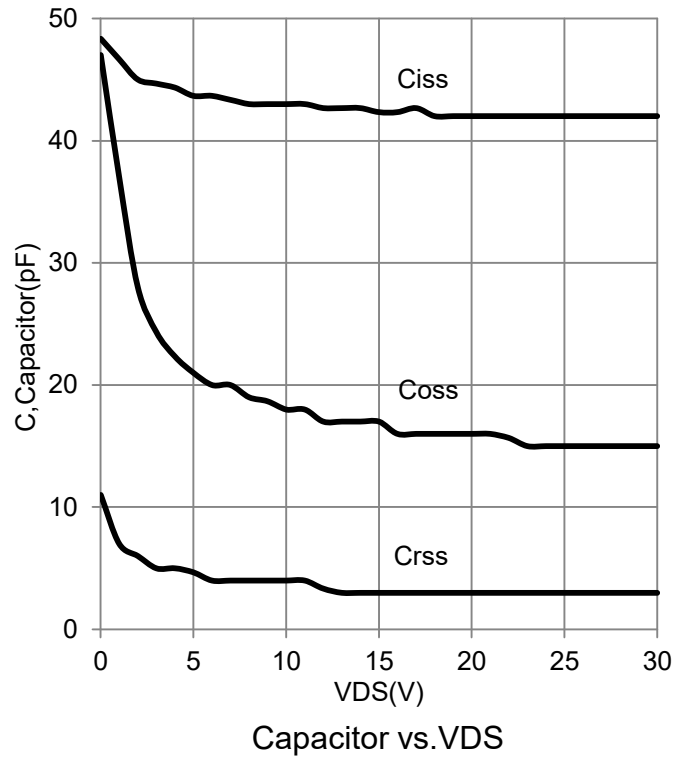
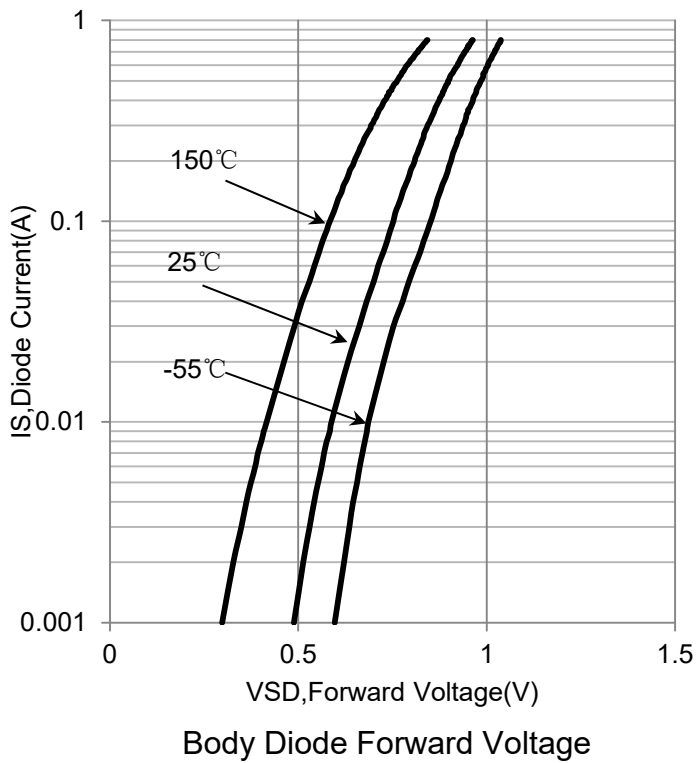

## 7. OUTLINE AND DIMENSIONS

Notes:

1. DIMENSIONING AND TOLERANCING PER ANSI Y14.5M, 1982.
2. CONTROLLING DIMENSION: MILLIMETERS.
3. MAXIMUM LEAD THICKNESS INCLUDES LEAD FINISH. MINIMUM LEAD THICKNESS IS THE MINIMUM THICKNESS OF BASE MATERIAL.
4. DIMENSIONS D AND E DO NOT INCLUDE MOLD FLASH, PROTRUSIONS OR GATE BURRS.

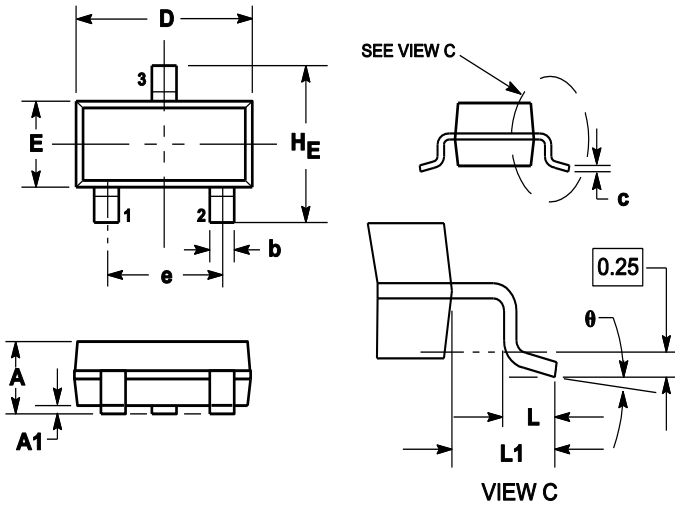

DIM	MILLIMETERS			INCHES		
	MIN	NOM	MAX	MIN	NOM	MAX
A	0.89	1	1.11	0.035	0.04	0.044
A1	0.01	0.06	0.1	0.001	0.002	0.004
b	0.37	0.44	0.5	0.015	0.018	0.02
c	0.09	0.13	0.18	0.003	0.005	0.007
D	2.80	2.9	3.04	0.11	0.114	0.12
E	1.20	1.3	1.4	0.047	0.051	0.055
e	1.78	1.9	2.04	0.07	0.075	0.081
L	0.10	0.2	0.3	0.004	0.008	0.012
L1	0.35	0.54	0.69	0.014	0.021	0.029
HE	2.10	2.4	2.64	0.083	0.094	0.104
θ	0°	---	10°	0°	---	10°

## 8. SOLDERING FOOTPRINT

