

Low Noise Transistor

PNP Silicon

- We declare that the material of product compliance with RoHS requirements.

MBT5087

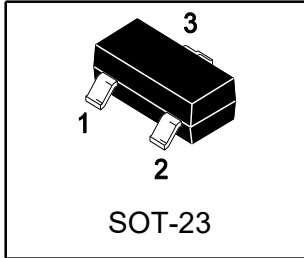

ORDERING INFORMATION

| Device | Marking | Shipping |
|---------|---------|------------------|
| MBT5087 | 2Q | 3000/Tape & Reel |

MAXIMUM RATINGS

| Rating | Symbol | Value | Unit |
|--------------------------------|-----------|-------|------|
| Collector–Emitter Voltage | V_{CEO} | - 50 | Vdc |
| Collector–Base Voltage | V_{CBO} | - 50 | Vdc |
| Emitter–Base Voltage | V_{EBO} | - 3.0 | Vdc |
| Collector Current — Continuous | I_C | - 50 | mAdc |

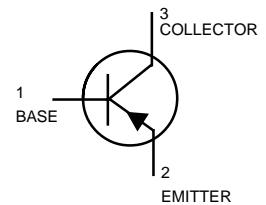

DEVICE MARKING

MBT5087 =2Q

THERMAL CHARACTERISTICS

| Characteristic | Symbol | Max | Unit |
|--|-----------------|-----------|--------------------|
| Total Device Dissipation RF-5 Board (1) $T_A = 25^\circ\text{C}$ Derate above 25°C | P_D | 225 | mW |
| Thermal Resistance, Junction to Ambient | $R_{\theta JA}$ | 556 | $^\circ\text{C/W}$ |
| Total Device Dissipation Alumina Substrate, (2) $T_A = 25^\circ\text{C}$ Derate above 25°C | P_D | 300 | mW |
| Thermal Resistance, Junction to Ambient | $R_{\theta JA}$ | 417 | $^\circ\text{C/W}$ |
| Junction and Storage Temperature | T_J, T_{stg} | -55to+150 | $^\circ\text{C}$ |

ELECTRICAL CHARACTERISTICS ($T_A = 25^\circ\text{C}$ unless otherwise noted)

| Characteristic | Symbol | Min | Max | Unit |
|----------------|--------|-----|-----|------|
|----------------|--------|-----|-----|------|

OFF CHARACTERISTICS

| | | | | |
|--|---------------|------|------------|-------|
| Collector–Emitter Breakdown Voltage ($I_C = -1.0\text{ mAdc}, I_E = 0$) | $V_{(BR)CEO}$ | - 50 | — | Vdc |
| Collector–Base Breakdown Voltage ($I_C = -100\ \mu\text{Adc}, I_E = 0$) | $V_{(BR)CBO}$ | - 50 | — | Vdc |
| Collector Cutoff Current ($V_{CB} = -10\text{ Vdc}, I_E = 0$) ($V_{CB} = -35\text{ Vdc}, I_E = 0$) | I_{CBO} | — | -10 -50 | n Adc |

1. FR-5 = 1.0 x 0.75 x 0.062 in.
2. Alumina = 0.4 x 0.3 x 0.024 in. 99.5% alumina.



ELECTRICAL CHARACTERISTICS ($T_A = 25^\circ\text{C}$ unless otherwise noted) (Continued)

| Characteristic | Symbol | Min | Max | Unit |
|--|---------------|-----|-------|------|
| DC CHARACTERISTICS | | | | |
| DC Current Gain ($I_C = -100\mu\text{Adc}$, $V_{CE} = -5.0\text{ Vdc}$) | h_{FE} | 250 | 800 | — |
| ($I_C = -1.0\text{ mAdc}$, $V_{CE} = -5.0\text{ Vdc}$) | | 250 | — | |
| ($I_C = -10\text{ mAdc}$, $V_{CE} = -5.0\text{ Vdc}$) | | 250 | — | |
| Collector–Emitter Saturation Voltage ($I_C = -10\text{ mAdc}$, $I_B = -1.0\text{ mAdc}$) | $V_{CE(sat)}$ | — | -0.3 | Vdc |
| Base–Emitter Saturation Voltage ($I_C = -10\text{ mAdc}$, $I_B = -1.0\text{ mAdc}$) | $V_{BE(sat)}$ | — | -0.85 | Vdc |

SMALL–SIGNAL CHARACTERISTICS

| | | | | |
|---|-----------|-----|-----|-----|
| Current–Gain — Bandwidth Product ($I_C = -500\mu\text{Adc}$, $V_{CE} = -5.0\text{ Vdc}$, $f = 20\text{ MHz}$) | f_T | 40 | — | MHz |
| Output Capacitance ($V_{CB} = -5.0\text{ Vdc}$, $I_E = 0$, $f = 1.0\text{ MHz}$) | C_{obo} | — | 4.0 | pF |
| Small–Signal Current Gain ($I_C = -1.0\text{ mAdc}$, $V_{CE} = -5.0\text{ Vdc}$, $f = 1.0\text{ kHz}$) | h_{fe} | 250 | 900 | — |
| Noise Figure ($I_C = -20\text{ mAdc}$, $V_{CE} = -5.0\text{ Vdc}$, $R_S = 10\text{ k}\Omega$, $f = 1.0\text{ kHz}$) | NF | — | 2.0 | dB |
| ($I_C = -100\mu\text{Adc}$, $V_{CE} = -5.0\text{ Vdc}$, $R_S = 3.0\text{ k}\Omega$, $f = 1.0\text{ kHz}$) | | — | 2.0 | |



TYPICAL NOISE CHARACTERISTICS

($V_{CE} = -5.0 \text{ Vdc}$, $T_A = 25^\circ\text{C}$)

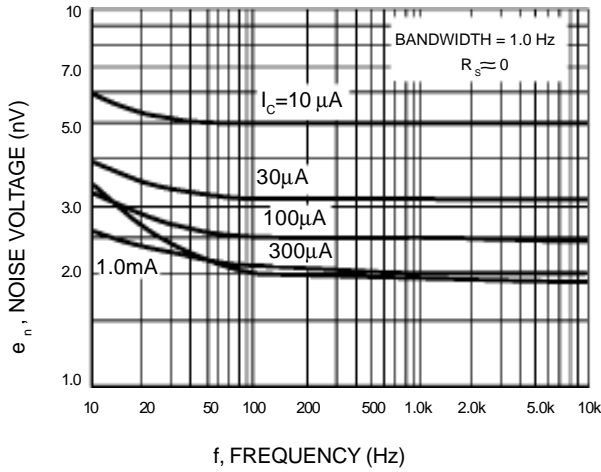

Figure 1. Noise Voltage

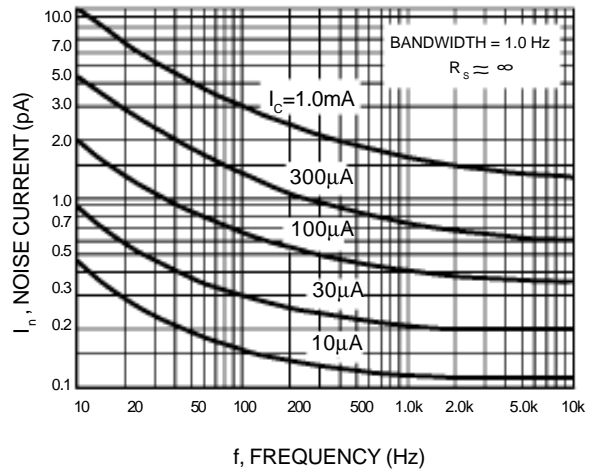

Figure 2. Noise Current

NOISE FIGURE CONTOURS

($V_{CE} = -5.0 \text{ Vdc}$, $T_A = 25^\circ\text{C}$)

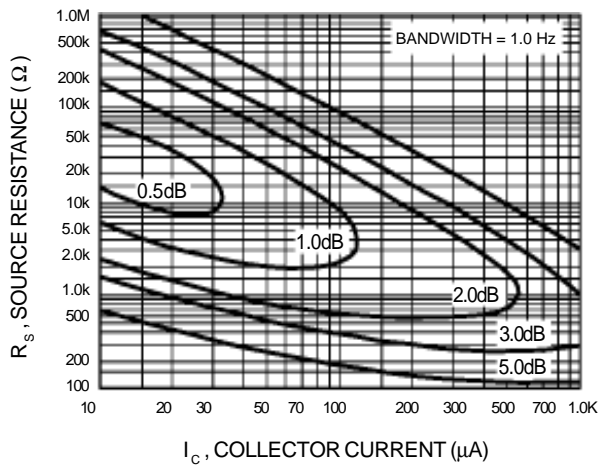

Figure 3. Narrow Band, 100 Hz

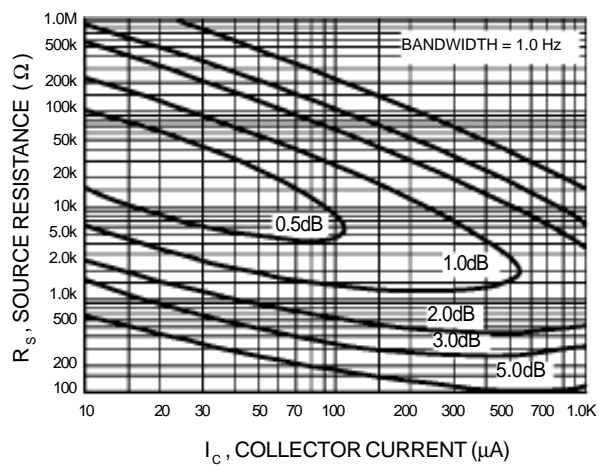

Figure 4. Narrow Band, 1.0 kHz

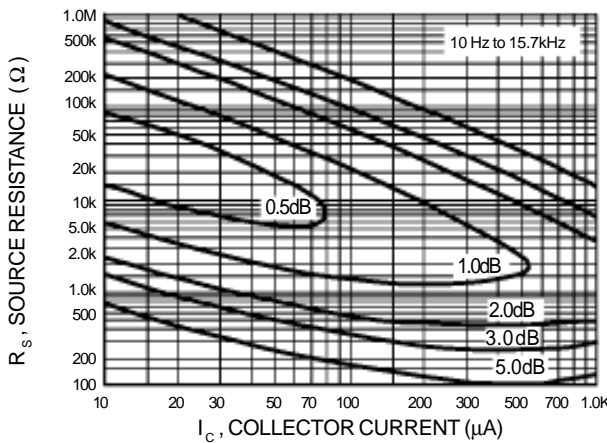

Figure 5. Wideband

Noise Figure is Defined as:

$$NF = 20 \log_{10} \left(\frac{e_n^2 + 4KTR_s + I_n^2 R_s^2}{4KTR_s} \right)^{1/2}$$

- e_n = Noise Voltage of the Transistor referred to the input. (Figure 3)
- I_n = Noise Current of the Transistor referred to the input. (Figure 4)
- K = Boltzman's Constant ($1.38 \times 10^{-23} \text{ J/}^\circ\text{K}$)
- T = Temperature of the Source Resistance ($^\circ\text{K}$)
- R_s = Source Resistance (Ω)



TYPICAL STATIC CHARACTERISTICS

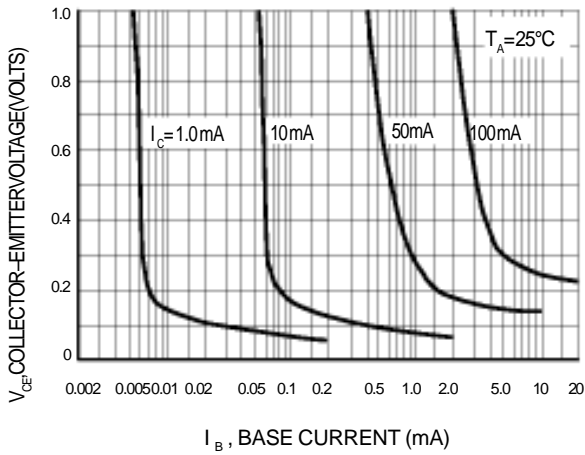

Figure 6. Collector Saturation Region

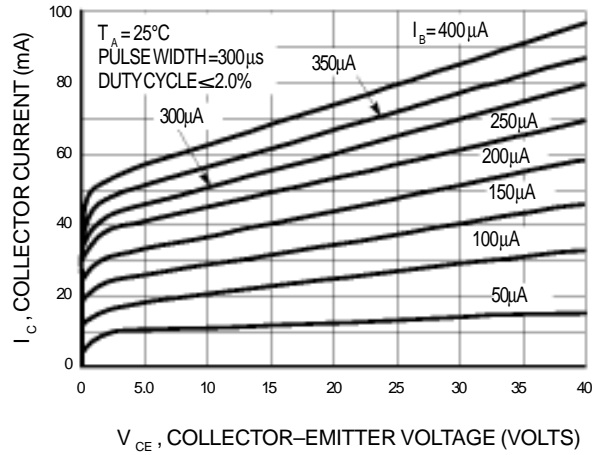

Figure 7. Collector Characteristics

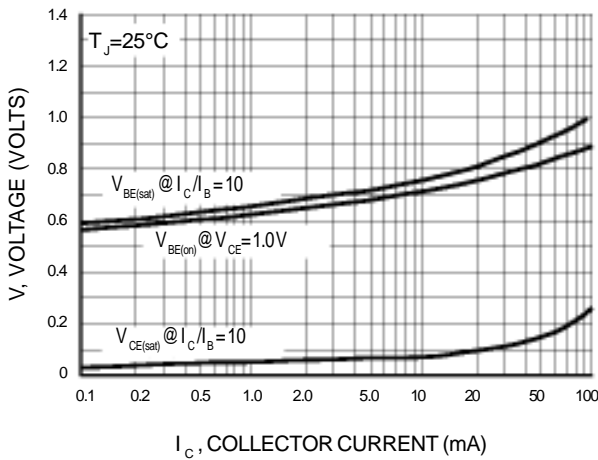

Figure 10. "On" Voltages

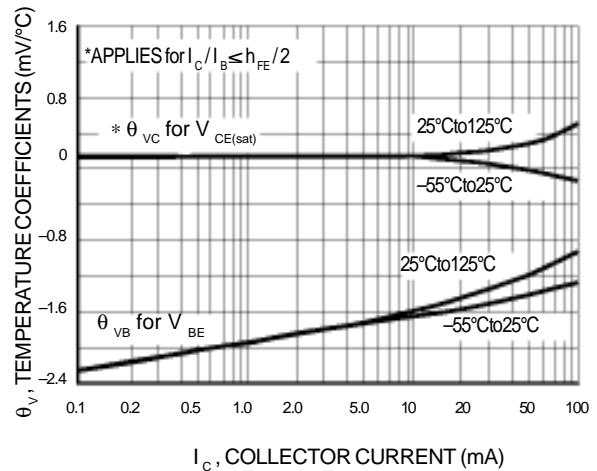

Figure 11. Temperature Coefficients



TYPICAL DYNAMIC CHARACTERISTICS

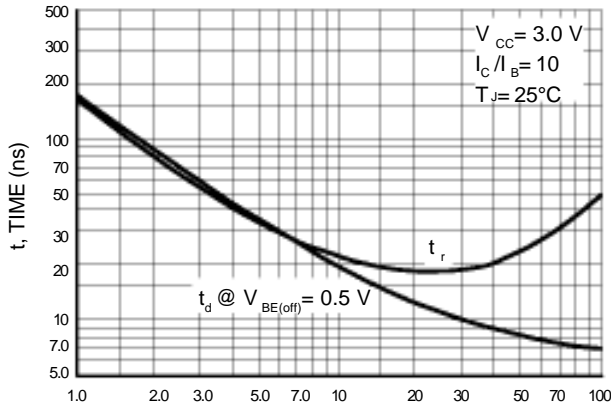

Figure 10. Turn-On Time

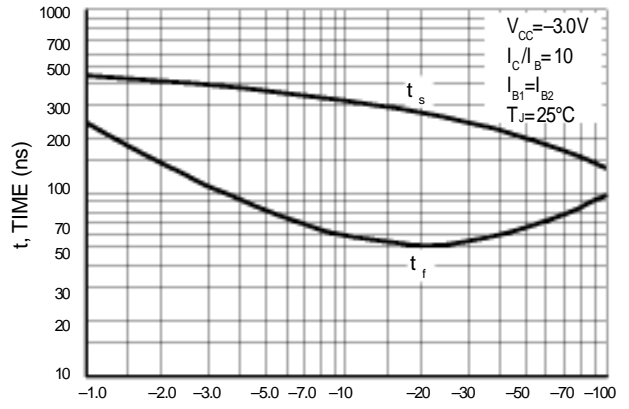

Figure 11. Turn-Off Time

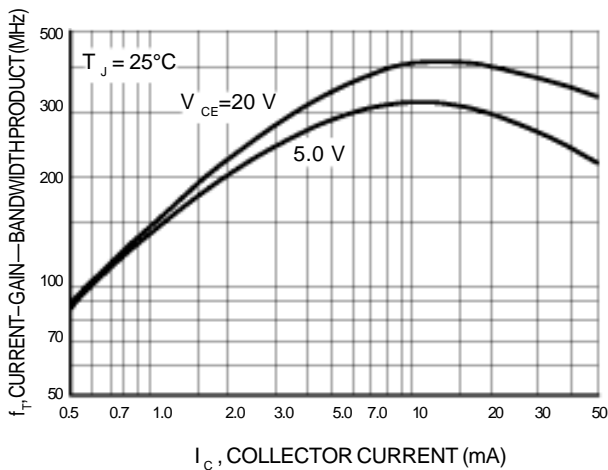

Figure 12. Current-Gain — Bandwidth Product

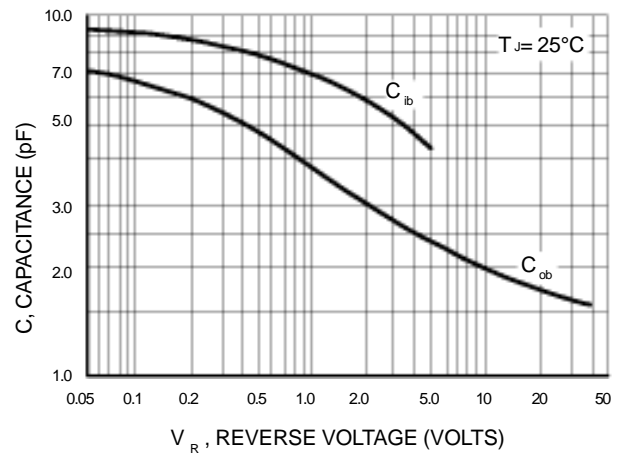

Figure 13. Capacitance

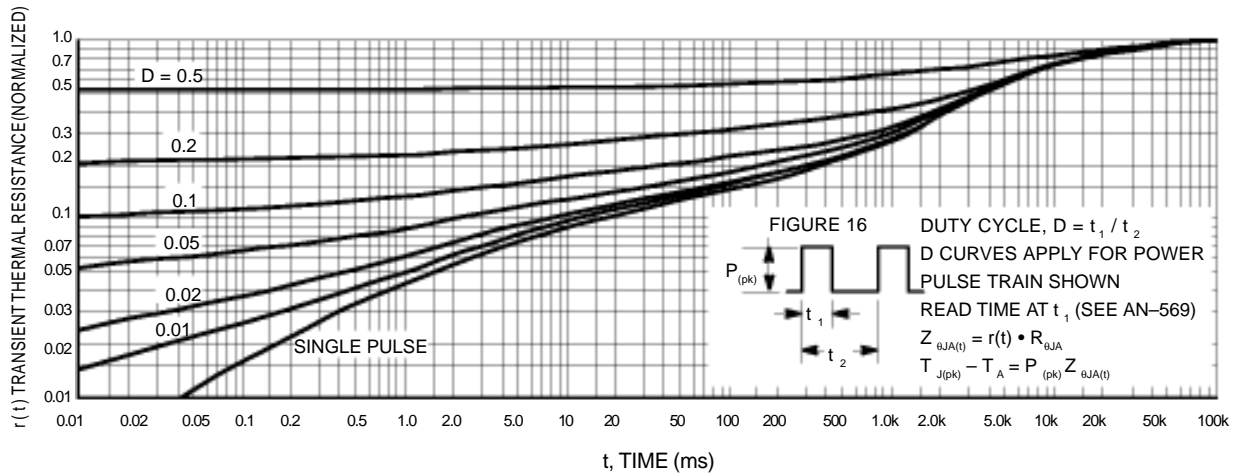

Figure 14. Thermal Response



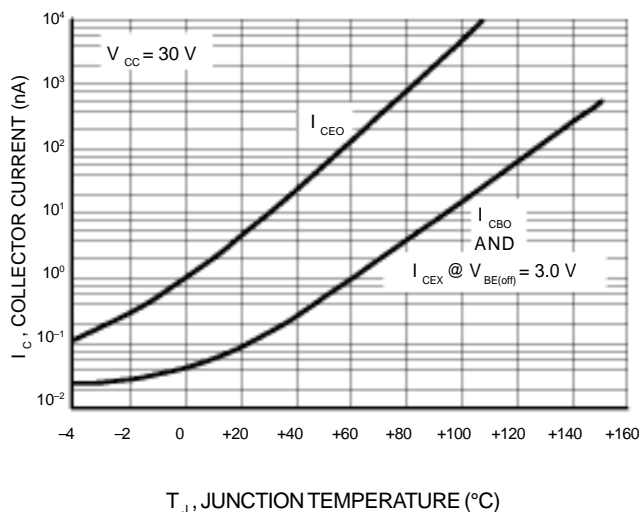

Figure 15. Typical Collector Leakage Current

DESIGN NOTE: USE OF THERMAL RESPONSE DATA

A train of periodical power pulses can be represented by the model as shown in Figure 16. Using the model and the device thermal response the normalized effective transient thermal resistance of Figure 14 was calculated for various duty cycles.

To find $Z_{\theta JA(t)}$, multiply the value obtained from Figure 14 by the steady state value $R_{\theta JA}$.

Example:

Dissipating 2.0 watts peak under the following conditions:

$$t_1 = 1.0 \text{ ms}, t_2 = 5.0 \text{ ms. (D = 0.2)}$$

Using Figure 16 at a pulse width of 1.0 ms and D = 0.2, the reading of r(t) is 0.22.

The peak rise in junction temperature is therefore

$$\Delta T = r(t) \times P_{(pk)} \times R_{\theta JA} = 0.22 \times 2.0 \times 200 = 88^\circ\text{C}.$$

For more information, see AN-569.



SOT-23

NOTES:

1. DIMENSIONING AND TOLERANCING PER ANSI Y14.5M,1982
2. CONTROLLING DIMENSION: INCH.

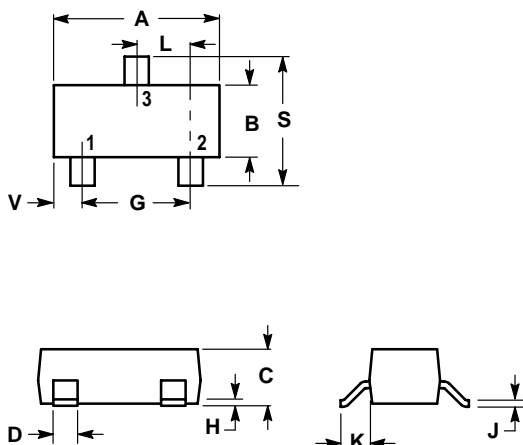

| DIM | INCHES | | MILLIMETERS | |
|-----|--------|--------|-------------|-------|
| | MIN | MAX | MIN | MAX |
| A | 0.1102 | 0.1197 | 2.80 | 3.04 |
| B | 0.0472 | 0.0551 | 1.20 | 1.40 |
| C | 0.0350 | 0.0440 | 0.89 | 1.11 |
| D | 0.0150 | 0.0200 | 0.37 | 0.50 |
| G | 0.0701 | 0.0807 | 1.78 | 2.04 |
| H | 0.0005 | 0.0040 | 0.013 | 0.100 |
| J | 0.0034 | 0.0070 | 0.085 | 0.177 |
| K | 0.0140 | 0.0285 | 0.35 | 0.69 |
| L | 0.0350 | 0.0401 | 0.89 | 1.02 |
| S | 0.0830 | 0.1039 | 2.10 | 2.64 |
| V | 0.0177 | 0.0236 | 0.45 | 0.60 |

