

# MBT4401W

# S-MBT4401W

General Purpose Transistors NPN Silicon

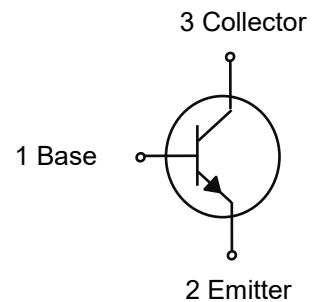
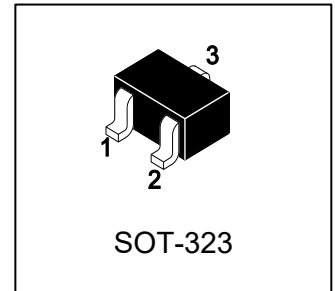

## 1. FEATURES

- We declare that the material of product compliance with RoHS requirements and Halogen Free.
- S- prefix for automotive and other applications requiring unique site and control change requirements; AEC-Q101 qualified and PPAP capable.

## 2. DEVICE MARKING AND ORDERING INFORMATION

Device	Marking	Shipping
MBT4401W	2X	3000/Tape&Reel

## 3. MAXIMUM RATINGS(Ta = 25°C)

Parameter	Symbol	Limits	Unit
Collector–Emitter Voltage	V <sub>CEO</sub>	40	V
Collector–Base Voltage	V <sub>CBO</sub>	60	V
Emitter–Base Voltage	V <sub>EBO</sub>	6	V
Collector Current — Continuous	I <sub>C</sub>	600	mA

## 4. THERMAL CHARACTERISTICS

Parameter	Symbol	Limits	Unit
Total Device Dissipation, FR-5 Board (Note 1) @ TA = 25°C	PD	150	mW
Thermal Resistance, Junction–to–Ambient(Note 1)	R <sub>θJA</sub>	833	°C/W
Junction and Storage temperature	T <sub>J</sub> , T <sub>stg</sub>	-55~+150	°C

1. FR-5 = 1.0×0.75×0.062 in.

## 5. ELECTRICAL CHARACTERISTICS (Ta= 25°C)

OFF CHARACTERISTICS

Characteristic	Symbol	Min.	Typ.	Max.	Unit
Collector–Emitter Breakdown Voltage (I <sub>C</sub> = 1.0 mA, I <sub>B</sub> = 0)	V <sub>BR</sub> (CEO)	40	-	-	V
Collector–Base Breakdown Voltage (I <sub>C</sub> = 0.1 mA, I <sub>E</sub> = 0)	V <sub>BR</sub> (CBO)	60	-	-	V
Emitter–Base Breakdown Voltage (I <sub>E</sub> = 0.1 mA, I <sub>C</sub> = 0)	V <sub>BR</sub> (EBO)	6	-	-	V
Collector Cutoff Current (V <sub>CE</sub> = 35 V, V <sub>EB</sub> = 0.4V)	I <sub>C</sub> EX	-	-	0.1	μA
Base Cutoff Current (V <sub>CE</sub> = 35 V, V <sub>EB</sub> = 0.4V)	I <sub>B</sub> EV	-	-	0.1	μA



**5. ELECTRICAL CHARACTERISTICS (Ta= 25°C)(Con.)**

ON CHARACTERISTICS (Note 2.)

DC Current Gain (IC = 0.1 mA, VCE = 1.0 V) (IC = 1.0 mA, VCE = 1.0 V) (IC = 10 mA, VCE = 1.0 V) (IC = 150 mA, VCE = 1.0 V) (IC = 500 mA, VCE = 2.0 V)	HFE	20 40 80 100 40	- - - - -	- - - 300 -	
Collector–Emitter Saturation Voltage (IC = 150 mA, IB = 15 mA) (IC = 500 mA, IB = 50 mA)	VCE(sat)	- -	- -	0.4 0.75	V
Base–Emitter Saturation Voltage (IC = 150 mA, IB = 15 mA) (IC = 500 mA, IB = 50 mA)	VBE(sat)	0.75 -	- -	0.95 1.2	V

SMALL–SIGNAL CHARACTERISTICS

Current–Gain — Bandwidth Product (IC = 20mA, VCE= 10V, f = 100MHz)	fT	250	-	-	MHz
Collector–Base Capacitance (VCB = 5.0 V, IE = 0, f = 1.0 MHz)	Ccb	-	-	6.5	pF
Emitter–Base Capacitance (VEB = 0.5 V, IC = 0, f = 1.0 MHz)	Ceb	-	-	30	pF
Input Impedance (VCE = 10 V, IC = 1.0 mA, f = 1.0 kHz)	hie	1	-	15	KΩ
Voltage Feedback Ratio (VCE = 10 V, IC = 1.0 mA, f = 1.0 kHz)	hre	0.1	-	8	X10 <sup>-4</sup>
Small–Signal Current Gain (VCE = 10 V, IC = 1.0 mA, f = 1.0 kHz)	hfe	40	-	500	
Output Admittance (VCE = 10 V, IC = 1.0 mA, f = 1.0 kHz)	hoe	1	-	30	μmhos

SWITCHING CHARACTERISTICS

Delay Time	(VCC = 30 V, VEB=2.0V, IC = 150 mA, IB1 = 15 mA)	td	-	-	15	ns
Rise Time		tr	-	-	20	
Storage Time	(VCC = 30 V, IC =150 mA, IB1 = IB2 =15 mA)	ts	-	-	225	
Fall Time		tf	-	-	30	

2.Pulse Test: Pulse Width ≤300 μs, Duty Cycle ≤2.0%.

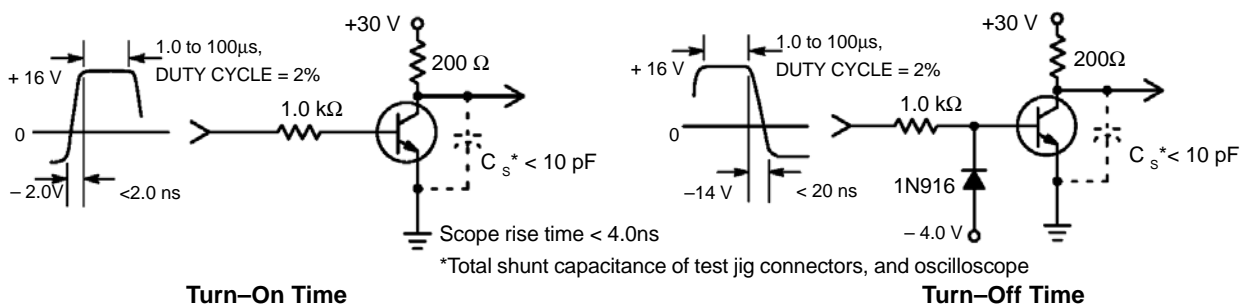
**SWITCHING TIME EQUIVALENT TEST CIRCUITS**

**6.ELECTRICAL CHARACTERISTICS CURVES**

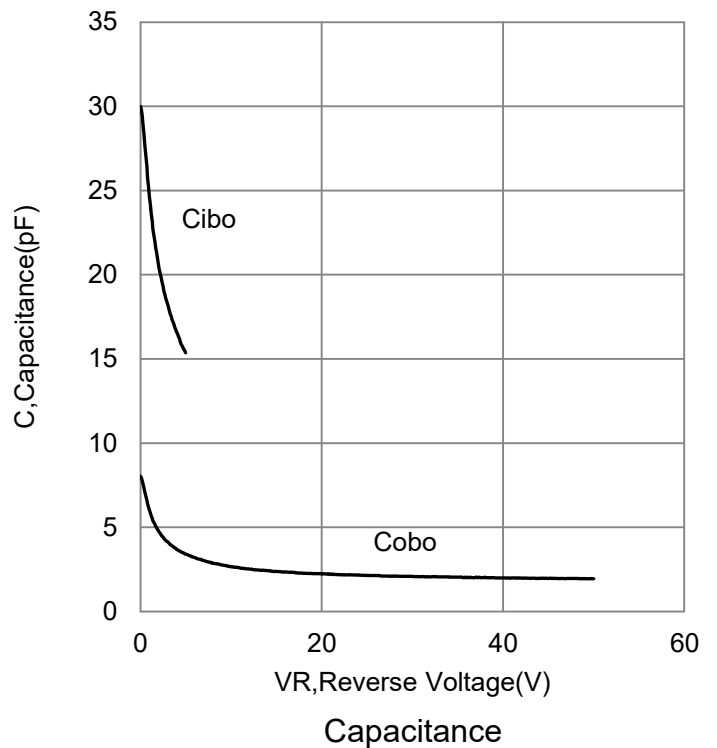
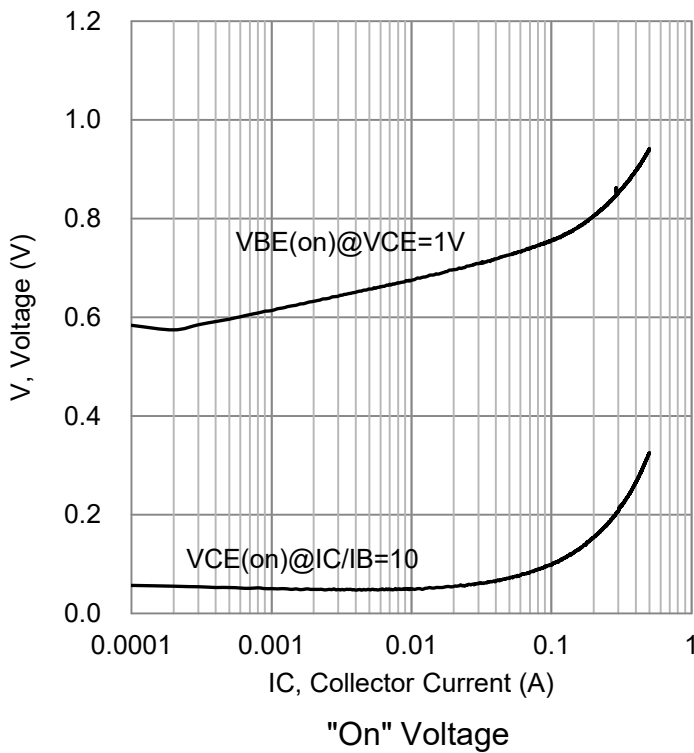
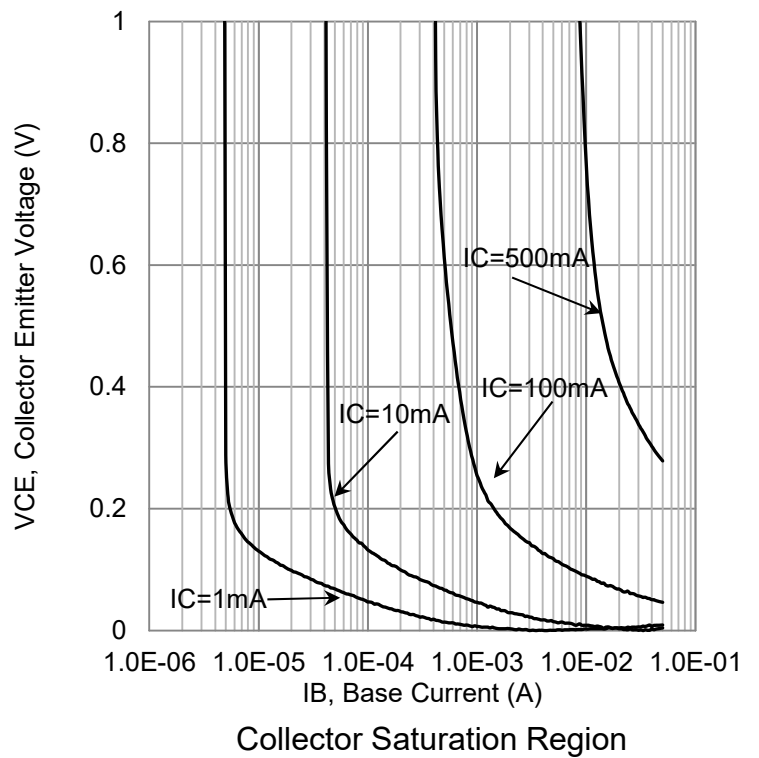
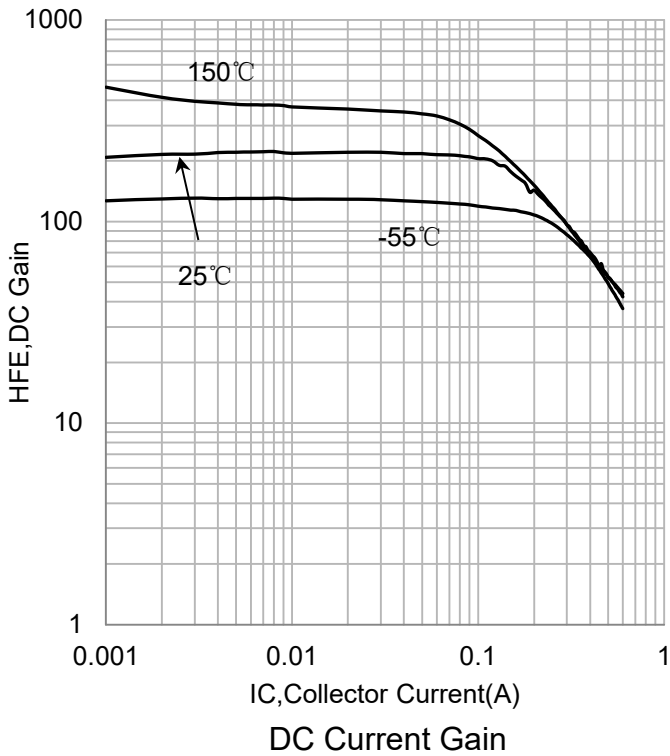

**6.ELECTRICAL CHARACTERISTICS CURVES(Con.)**

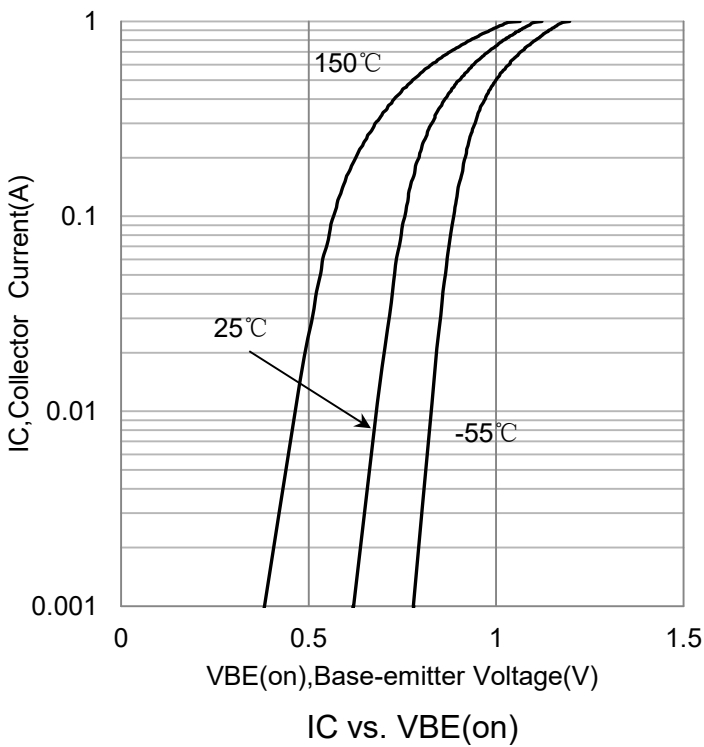
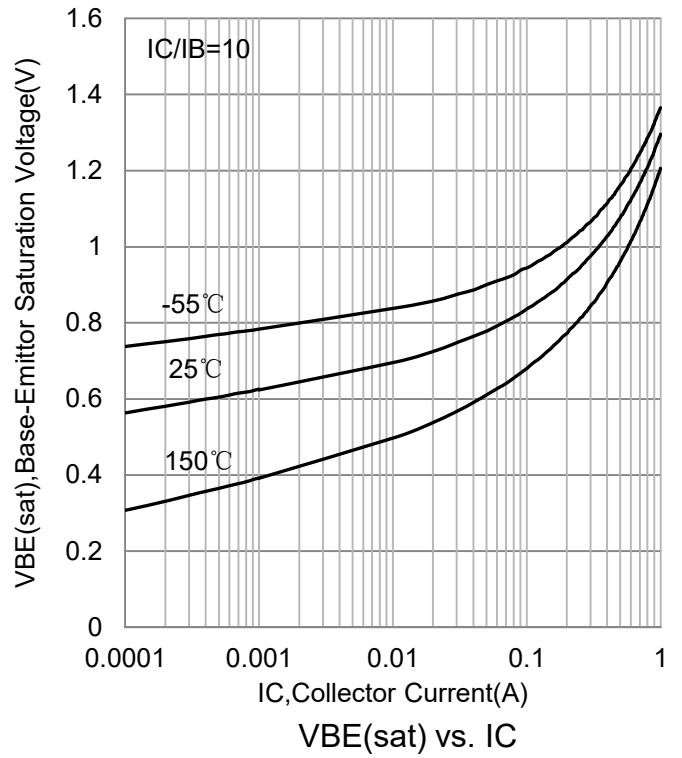
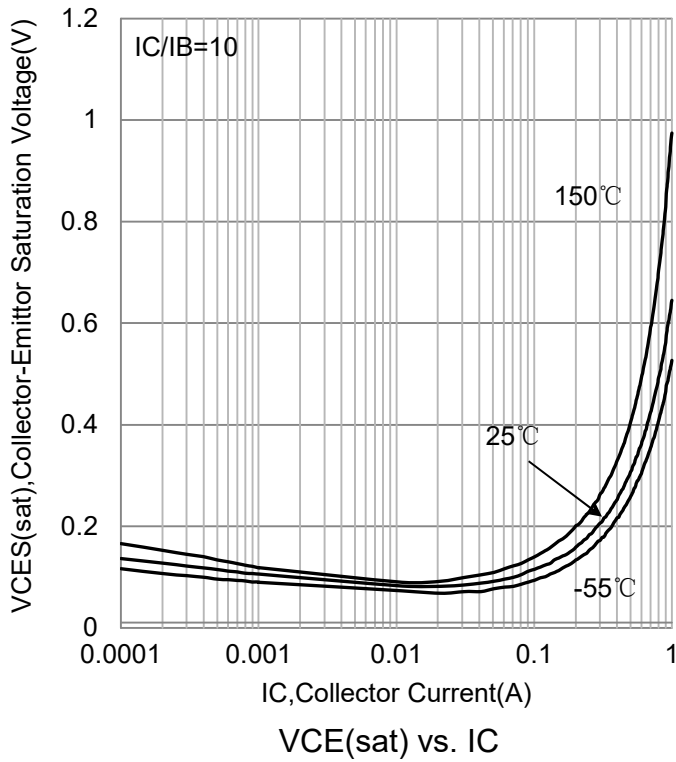

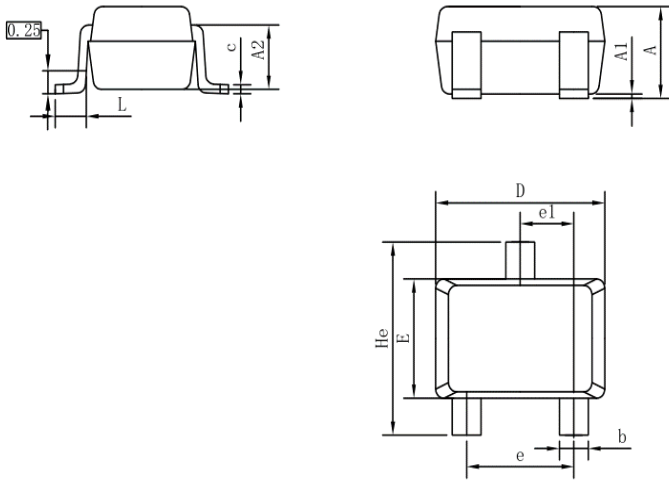
**7. OUTLINE AND DIMENSIONS**

SOT-323			
DIM	MIN	NOR	MAX
A	0.80	0.95	1.00
A1	0.00	0.05	0.10
A2	0.7 REF		
b	0.30	0.35	0.40
c	0.10	0.15	0.25
D	1.80	2.05	2.20
E	1.15	1.30	1.35
e	1.20	1.30	1.40
e1	0.65 BSC		
L	0.20	0.35	0.56
He	2.00	2.10	2.40
ALL Dimension in mm			

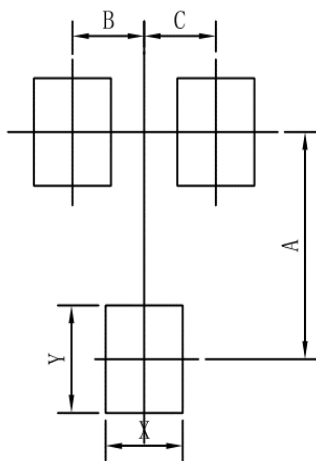
**8. SOLDERING FOOTPRINT**

SOT-323	
DIM	MIN
A	1.90
B	0.65
C	0.65
X	0.70
Y	0.90

