

MBT2222A

S-MBT2222A

General Purpose Transistors NPN Silicon

1. FEATURES

- We declare that the material of product compliance with RoHS requirements and Halogen Free.
- S- prefix for automotive and other applications requiring unique site and control change requirements; AEC-Q101 qualified and PPAP capable.

2. DEVICE MARKING AND ORDERING INFORMATION

Device	Marking	Shipping
MBT2222A	1P	3000/Tape&Reel

3. MAXIMUM RATINGS(Ta = 25°C)

Parameter	Symbol	Limits	Unit
Collector–Emitter Voltage	VCEO	40	V
Collector–Base Voltage	VCBO	75	V
Emitter–Base Voltage	VEBO	6	V
Collector Current — Continuous	IC	600	mA

4. THERMAL CHARACTERISTICS

Parameter	Symbol	Limits	Unit
Total Device Dissipation, FR-5 Board (Note 1) @ TA = 25°C Derate above 25°C	PD	225 1.8	mW mW/°C
Thermal Resistance, Junction–to–Ambient(Note 1)	RθJA	556	°C/W
Junction–to–Case	RθJC	300	°C/W
Junction and Storage temperature	TJ,Tstg	-55~+150	°C

1. FR-5 = 1.0×0.75×0.062 in.

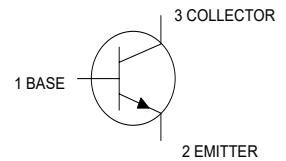
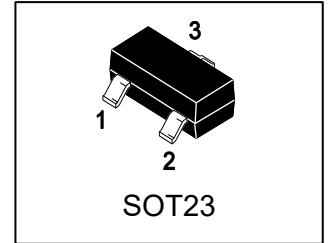

5. ELECTRICAL CHARACTERISTICS (Ta= 25°C)

OFF CHARACTERISTICS

Characteristic	Symbol	Min.	Typ.	Max.	Unit
Collector–Emitter Breakdown Voltage (IC = 10 mA, IB = 0)	VBR(CEO)	40	-	-	V
Collector–Base Breakdown Voltage (IC = 10 μA, IE = 0)	VBR(CBO)	75	-	-	V
Emitter–Base Breakdown Voltage (IE = 10 μA, IC = 0)	VBR(EBO)	6	-	-	V
Collector Cutoff Current (VCE = 60 V, VEB(off) = 3.0V)	ICEX	-	-	10	nA
Collector Cutoff Current (VCB = 60 V, IE = 0) (VCB = 60 V, IE = 0, TA = 125°C)	ICBO	-	-	0.01 10	μA
Emitter Cutoff Current (VEB = 3.0 V, IC = 0)	IEBO	-	-	100	nA
Collector-Emitter cutoff Current (VCE = 40V, IB=0)	ICEO	-	-	10	μA
Base Cutoff Current (VCE = 60 V, VEB(off) = 3.0 V)	IBL	-	-	20	nA

ON CHARACTERISTICS (Note 2.)

DC Current Gain (IC = 0.1 mA, VCE = 10 V) (IC = 1.0 mA, VCE = 10 V) (IC = 10 mA, VCE = 10 V) (IC = 10 mA, VCE = 10 V, TA= -55°C) (IC = 150 mA, VCE = 10 V) (IC = 150 mA, VCE = 1.0 V) (IC = 500 mA, VCE = 10 V)	HFE	35 50 75 35 100 50 40	- - - - - - -	- - - - 300 - -	
Collector–Emitter Saturation Voltage (IC = 150 mA, IB = 15 mA) (IC = 500 mA, IB = 50 mA)	VCE(sat)	- -	- -	0.3 1	V
Base–Emitter Saturation Voltage (IC = 150 mA, IB = 15 mA) (IC = 500 mA, IB = 50 mA)	VBE(sat)	0.6 -	- -	1.2 2	V

SMALL–SIGNAL CHARACTERISTICS

Current–Gain — Bandwidth Product (IC = 20mA, VCE= 20V, f = 100MHz)	fT	300	-	-	MHz
Output Capacitance (VCB = 5.0 V, IE = 0, f = 1.0 MHz)	Cobo	-	-	8	pF
Input Capacitance (VEB = 0.5 V, IC = 0, f = 1.0 MHz)	Cibo	-	-	25	pF



5. ELECTRICAL CHARACTERISTICS (Ta= 25°C)

SWITCHING CHARACTERISTICS

Delay Time	(VCC = 30 V, VEB=-0.5V, IC = 150mA, IB1 = 15 mA)	td	-	-	10	ns
Rise Time		tr	-	-	25	
Storage Time	(VCC = 30 V, IC = 150 mA, IB1 = IB2 = 15 mA)	ts	-	-	225	
Fall Time		tf	-	-	60	

2.Pulse Test: Pulse Width ≤300 μs, Duty Cycle ≤2.0%.





6.ELECTRICAL CHARACTERISTICS CURVES

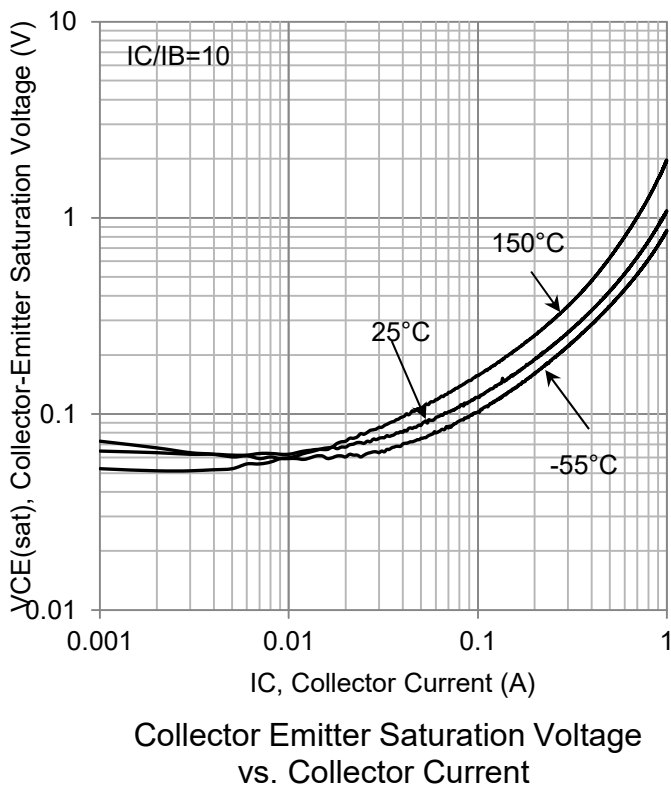
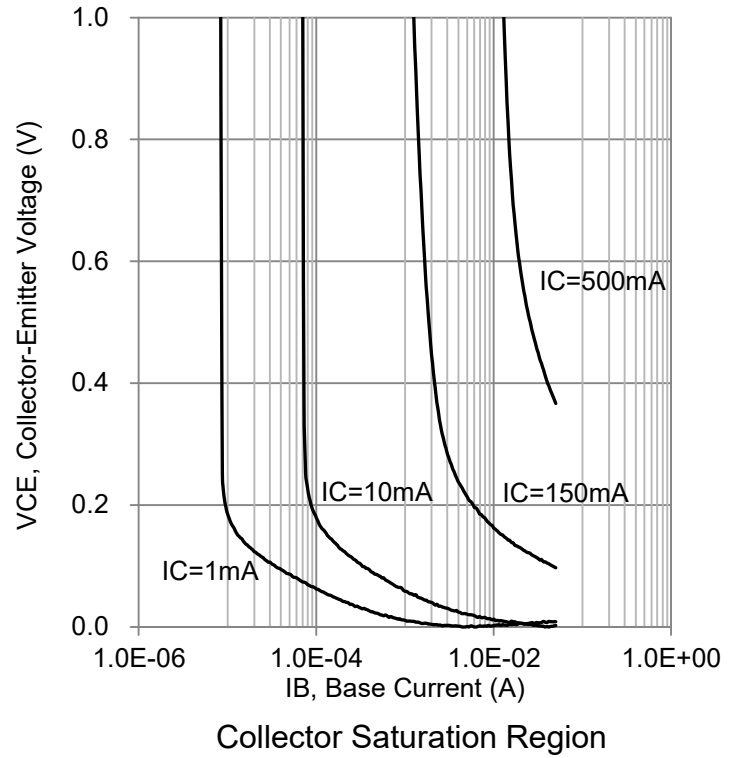
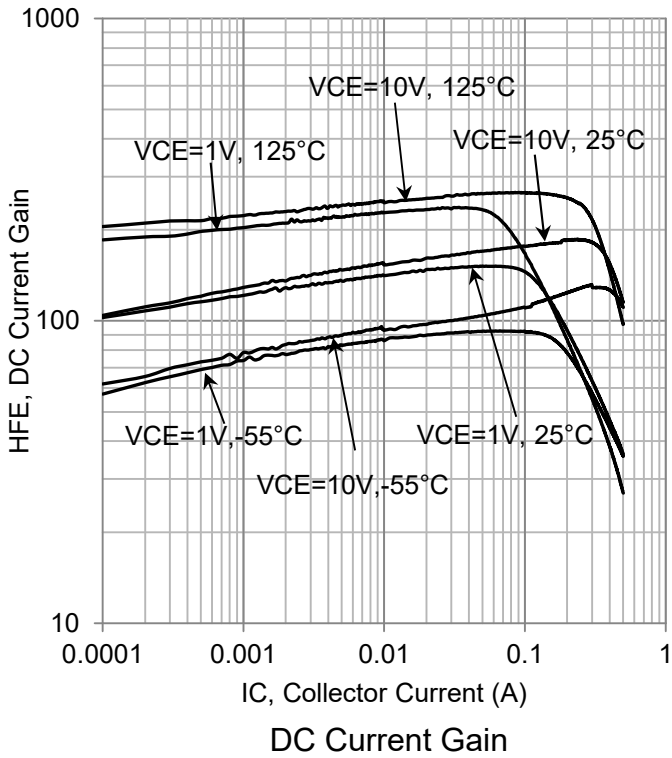

Collector Emitter Saturation Voltage vs. Collector Current

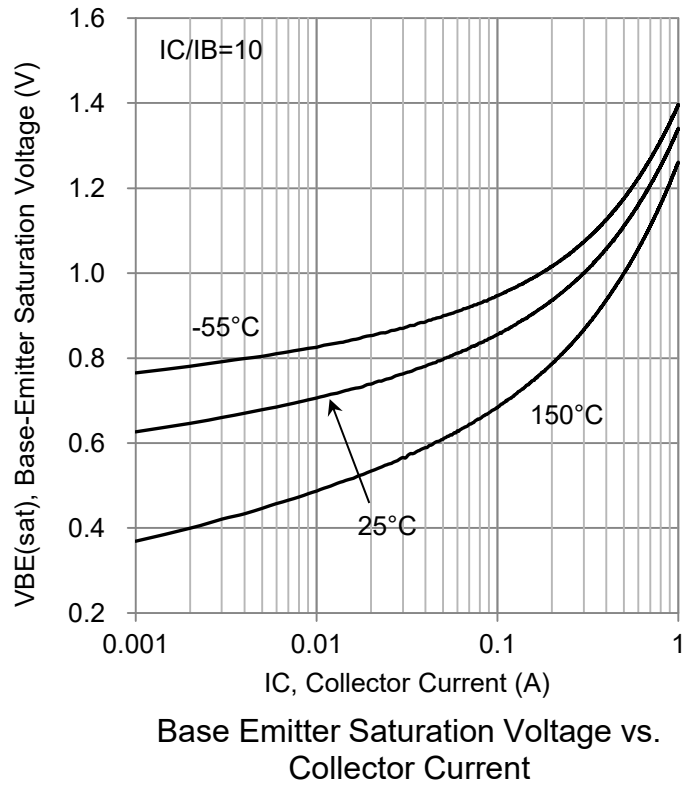

Base Emitter Saturation Voltage vs. Collector Current





6.ELECTRICAL CHARACTERISTICS CURVES(Con.)

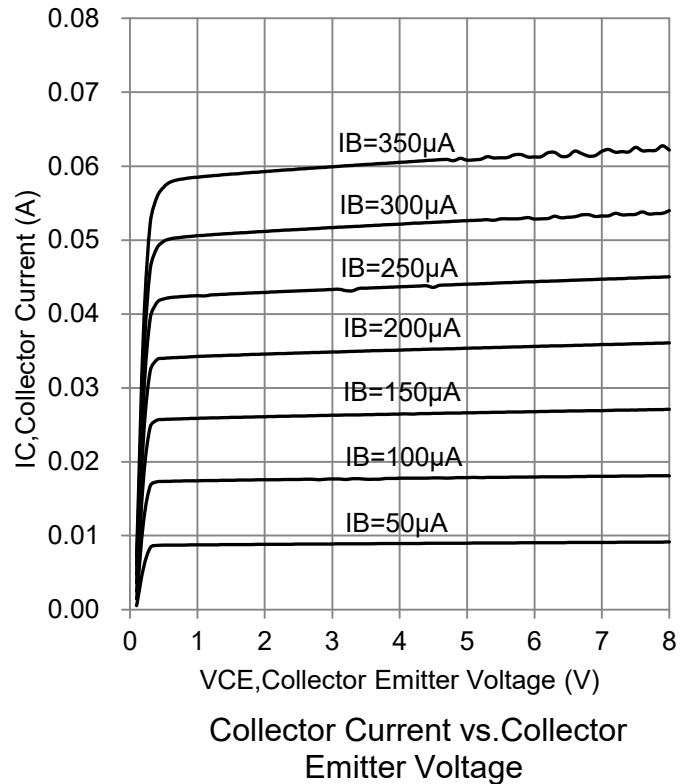
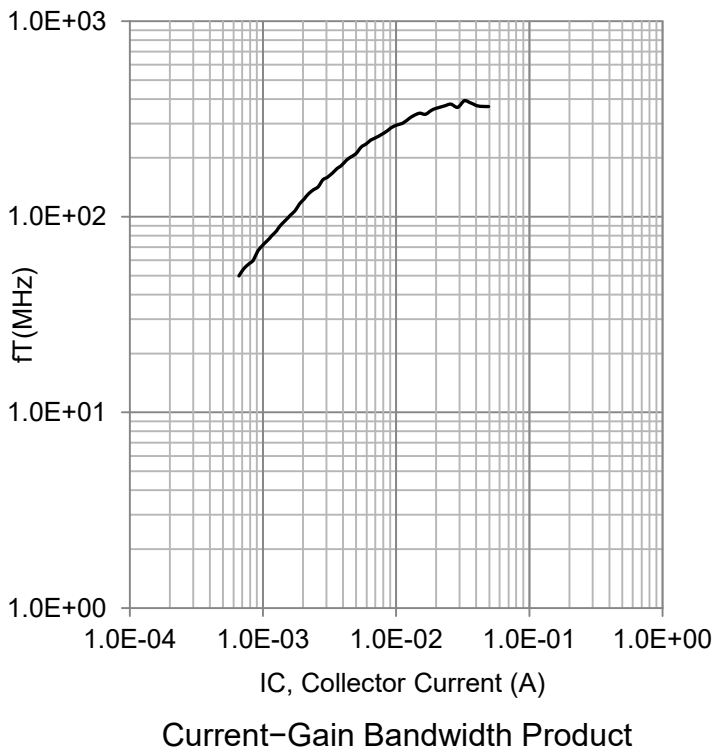
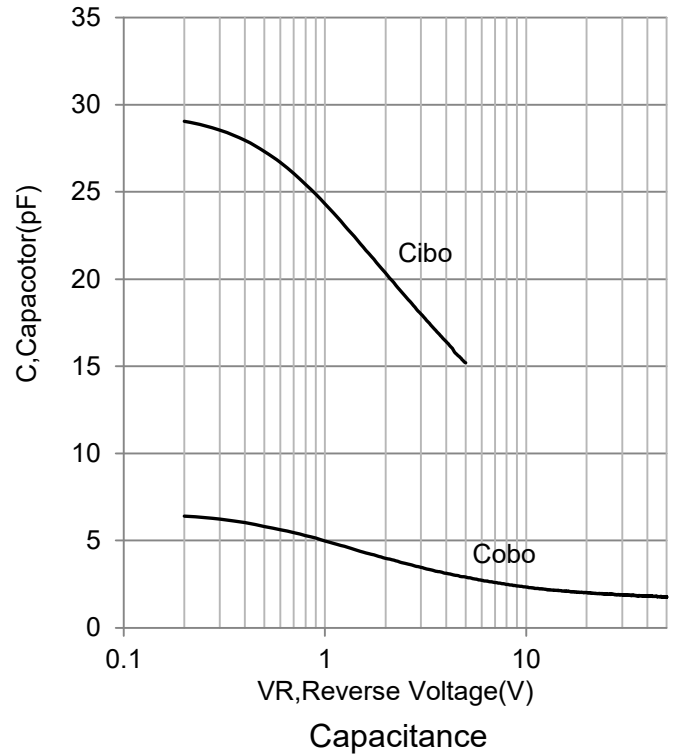
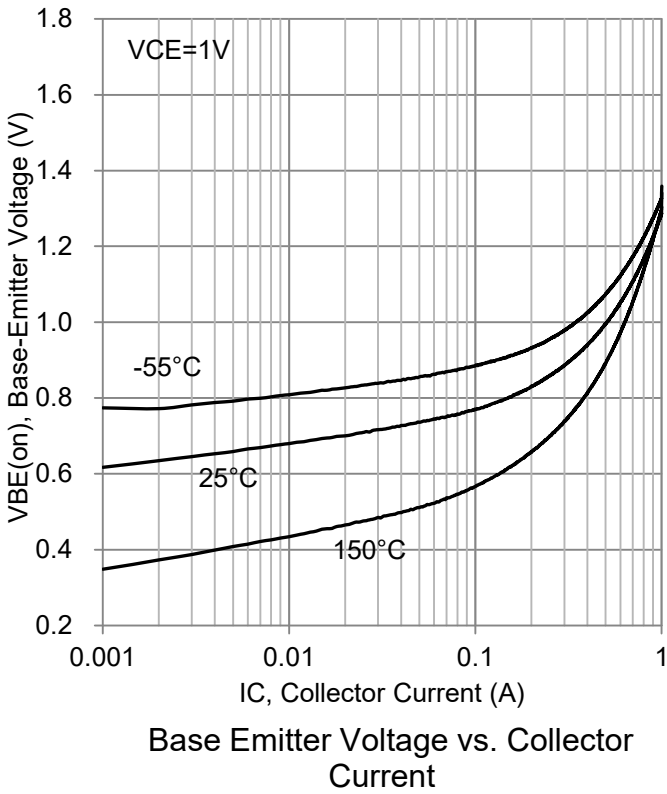

7.OUTLINE AND DIMENSIONS

Notes:

1. DIMENSIONING AND TOLERANCING PER ANSI Y14.5M, 1982.
2. CONTROLLING DIMENSION: MILLIMETERS.
3. MAXIMUM LEAD THICKNESS INCLUDES LEAD FINISH. MINIMUM LEAD THICKNESS IS THE MINIMUM THICKNESS OF BASE MATERIAL.
4. DIMENSIONS D AND E DO NOT INCLUDE MOLD FLASH, PROTRUSIONS OR GATE BURRS.

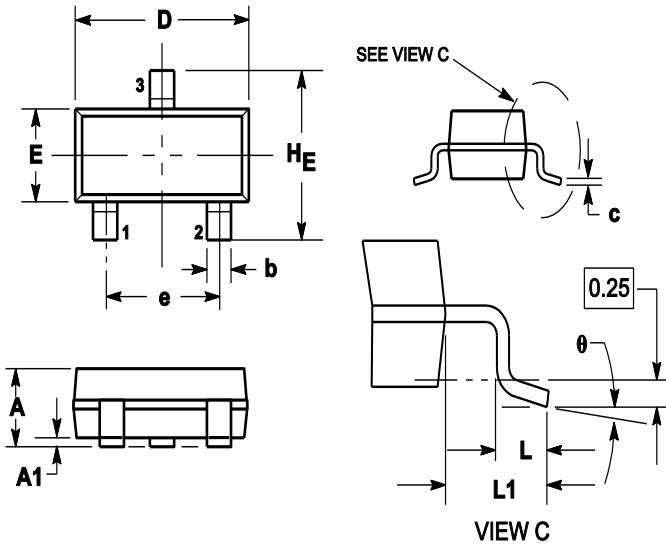

DIM	MILLIMETERS			INCHES		
	MIN	NOM	MAX	MIN	NOM	MAX
A	0.89	1	1.11	0.035	0.04	0.044
A1	0.01	0.06	0.1	0.001	0.002	0.004
b	0.37	0.44	0.5	0.015	0.018	0.02
c	0.09	0.13	0.18	0.003	0.005	0.007
D	2.80	2.9	3.04	0.11	0.114	0.12
E	1.20	1.3	1.4	0.047	0.051	0.055
e	1.78	1.9	2.04	0.07	0.075	0.081
L	0.10	0.2	0.3	0.004	0.008	0.012
L1	0.35	0.54	0.69	0.014	0.021	0.029
HE	2.10	2.4	2.64	0.083	0.094	0.104
θ	0°	---	10°	0°	---	10°

8.SOLDERING FOOTPRINT

