

BAT54CL

S-BAT54CL

Dual Series Schottky Barrier Diode

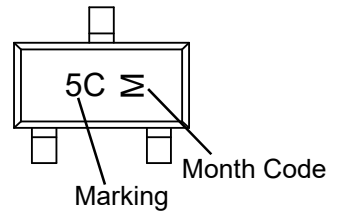
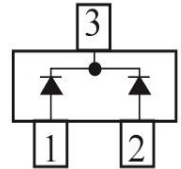
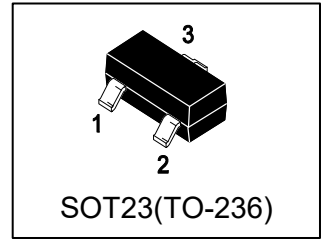

1. FEATURES

- We declare that the material of product compliance with RoHS requirements and Halogen Free.
- S- prefix for automotive and other applications requiring unique site and control change requirements; AEC-Q101 qualified and PPAP capable.
- Extremely Fast Switching Speed
- Low Forward Voltage — 0.35 V (Typ) @ IF = 10 mA

2. DEVICE MARKING AND ORDERING INFORMATION

Device	Marking	Shipping
BAT54CL	5C	3000/Tape&Reel

3. MAXIMUM RATINGS(Ta = 25°C)

Parameter	Symbol	Limits	Unit
Reverse Voltage	VR	30	V
Forward Current	IF	200	mA

4. THERMAL CHARACTERISTICS

Parameter	Symbol	Limits	Unit
Total Device Dissipation, FR-5 Board (Note 1) @ TA = 25°C Derate above 25°C	PD	225 2.25	mW mW/°C
Thermal Resistance, Junction-to-Ambient(Note 1)	RθJA	445	°C/W
Junction and Storage temperature	TJ, Tstg	-55~+125	°C

1. FR-5 = 1.0×0.75×0.062 in.



5. ELECTRICAL CHARACTERISTICS (Ta= 25°C)

Characteristic	Symbol	Min.	Typ.	Max.	Unit
Reverse Breakdown Voltage (IR = 10μA)	VBR	30	-	-	V
Reverse Voltage Leakage Current (VR = 25V)	IR	-	0.5	2	μA
Diode Capacitance (VR = 1.0V , f = 1.0 MHz)	CT	-	-	10	pF
Forward Voltage (IF = 0.1 mA) (IF = 1 mA) (IF = 10 mA) (IF = 30 mA) (IF = 100 mA)	VF	-	0.22 0.29 0.35 0.41 0.52	0.24 0.32 0.4 0.5 1	V
Reverse Recovery Time (IF = IR = 10 mA, IR(REC) = 1.0 mA)	trr	-	-	5	ns
Repetitive Peak Forward Current	IFRM	-	-	300	mA
Non–Repetitive Peak Forward Current (t < 1.0 s)	IFSM	-	-	600	mA



6. ELECTRICAL CHARACTERISTICS CURVES

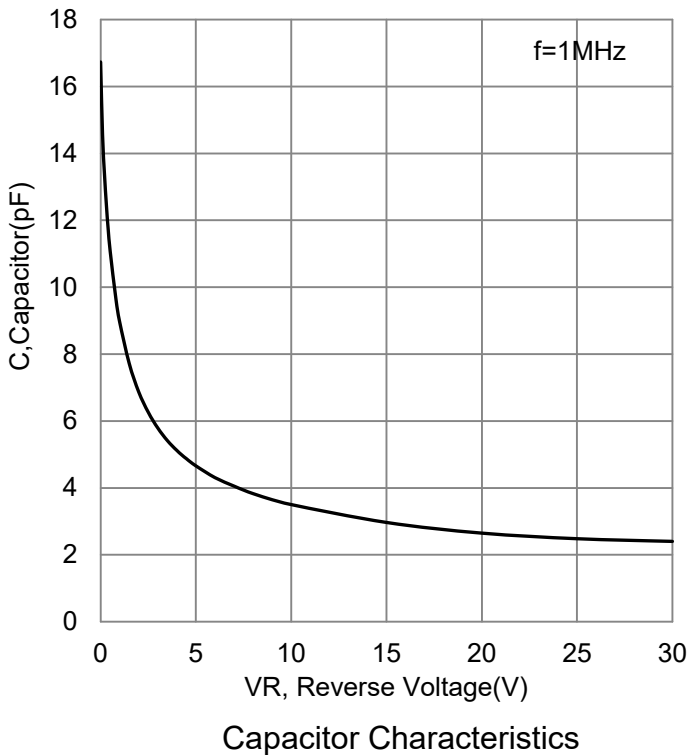
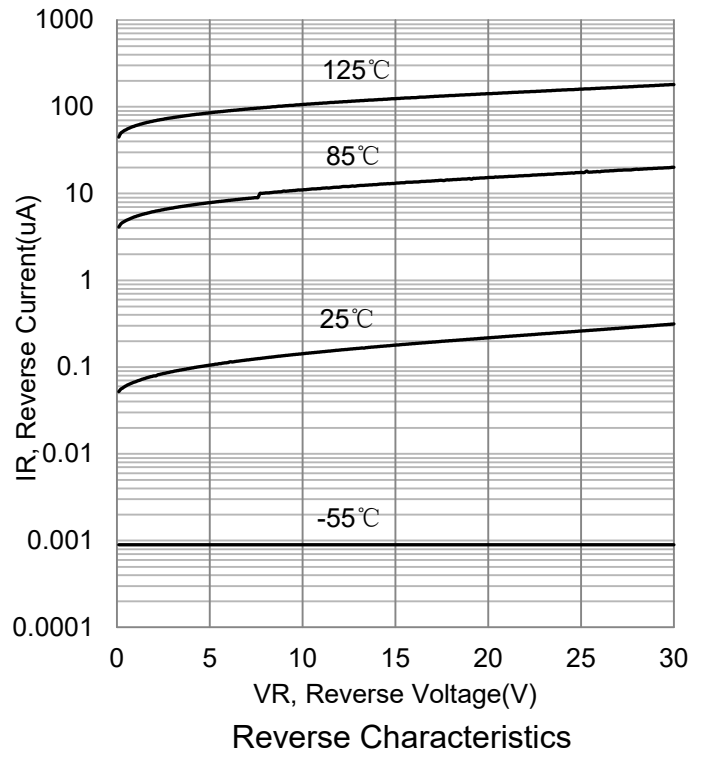
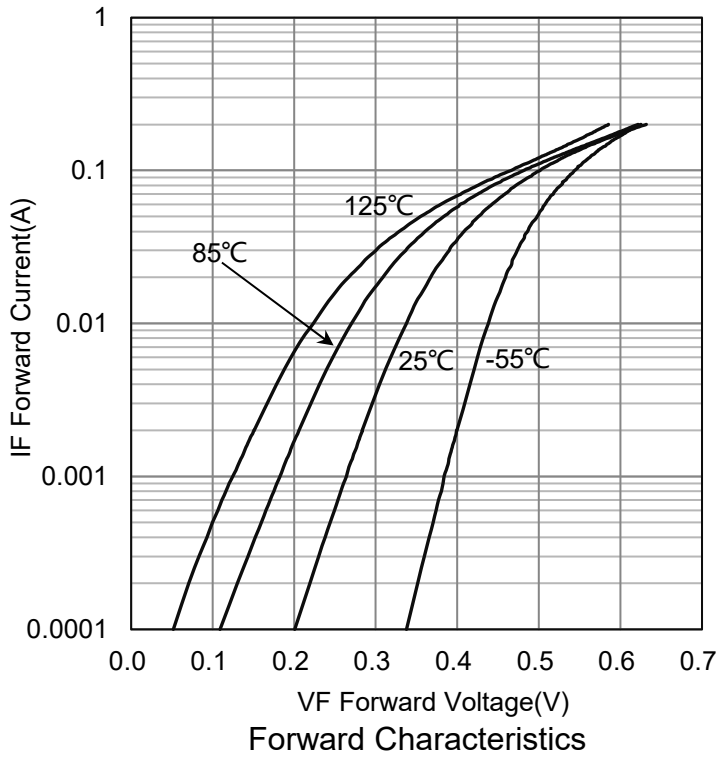

7. OUTLINE AND DIMENSIONS

Notes:

1. DIMENSIONING AND TOLERANCING PER ANSI Y14.5M, 1982.
2. CONTROLLING DIMENSION: MILLIMETERS.
3. MAXIMUM LEAD THICKNESS INCLUDES LEAD FINISH. MINIMUM LEAD THICKNESS IS THE MINIMUM THICKNESS OF BASE MATERIAL.
4. DIMENSIONS D AND E DO NOT INCLUDE MOLD FLASH, PROTRUSIONS OR GATE BURRS.

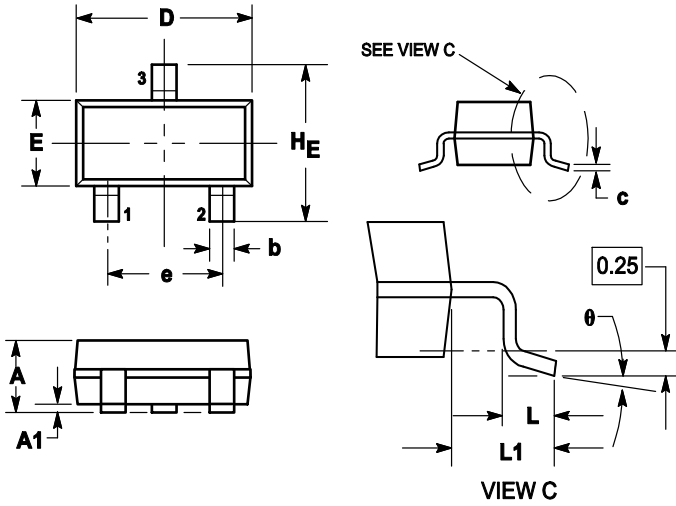

DIM	MILLIMETERS			INCHES		
	MIN	NOM	MAX	MIN	NOM	MAX
A	0.89	1	1.11	0.035	0.04	0.044
A1	0.01	0.06	0.1	0.001	0.002	0.004
b	0.37	0.44	0.5	0.015	0.018	0.02
c	0.09	0.13	0.18	0.003	0.005	0.007
D	2.80	2.9	3.04	0.11	0.114	0.12
E	1.20	1.3	1.4	0.047	0.051	0.055
e	1.78	1.9	2.04	0.07	0.075	0.081
L	0.10	0.2	0.3	0.004	0.008	0.012
L1	0.35	0.54	0.69	0.014	0.021	0.029
HE	2.10	2.4	2.64	0.083	0.094	0.104
θ	0°	---	10°	0°	---	10°

8. SOLDERING FOOTPRINT

