

深圳市瑞隆源电子有限公司 Shenzhen RUILONGYUAN Electronics Co.,Ltd.			
产品名称 Product name	低压电涌保护器 Low-voltage Surge Protective Devices	产品型号 Product type	TM10-320C
文件编号 File serial number	SP-SPD-107	产品编码 Product code	10.20.25.3201- 1001
类别 Classification	<input type="checkbox"/> 参考阶段 Reference <input type="checkbox"/> 正式承认 Qualified	<input type="checkbox"/> 样品阶段 Sample <input checked="" type="checkbox"/> 工程变更 Changed	

TM10-320C

低压电涌保护器技术规格书

Low-voltage Surge Protective Device Technical Specification

拟制:	Lucy	日期:	2024.09.10
Prepared by	_____	Date	_____
审核:	Jim	日期:	2024.09.10
Reviewed by	_____	Date	_____
批准:	Robert	日期:	2024.09.10
Approved by	_____	Date	_____

深圳市瑞隆源电子有限公司

Shenzhen RUILONGYUAN Electronics Co.,Ltd.

修订记录 Revision History

版本 Revision Version	描述 Description	页码 Page	日期 Date
X0	参考阶段 Reference	14	2022.09.06
A0	正式承认 Qualified	14	2023.03.15
A1	工程变更 Changed	14	2023.05.17
A2	工程变更 Changed	14	2023.06.14
A3	3.3 产品尺寸更新 Product size updates	14	2024.09.10

目录 Catalogue

1.适用范围 Scope	4
2.术语 Glossary.....	4
3.结构尺寸 Structure and Dimensions.....	6
3.1 结构图 Structure	6
3.2 主要原材料明细 Main Material List.....	7
3.3 产品尺寸 Product Dimensions.....	7
3.4 电路图 Circuit Diagram.....	7
4.安规认证 Agency Approvals	8
5.环保 Environment.....	8
6.技术参数 Specifications.....	8
7.检验方法和标准 Inspection Method & Standards	9
8.安全预防措施 Safety Precautions	11
9.标示及包装 Marks and Package	13
10.产品批号&追溯号识别 Lot No. & Tracking No. System.....	14
11.储存条件和有效日期 Storage Conditions and Effective Date.....	14
12.有效性 Validity	14
12.1 修订协议 Agreement of Revision	14
12.2 有效性 Validity.....	14

1. 适用范围 Scope

TM10-320C 低压电涌保护器应用于户外路灯、景观灯、交通信号灯等照明电源的电涌保护，抑制和泄放因感应雷或低压配电系统内部所产生的过电流和过电压，保护用电设备免受损害。本产品适用于 110V-277V 的交流供电系统，采用全模式的保护方式，使用软导线与外电路并联连接。

浪涌防护等级：

IEC/EN 61643-11 标称放电电流 5kA，最大放电电流 10kA，开路电压 10kV；

GB/T18802.11-2020 标称放电电流 5kA，最大放电电流 10kA，开路电压 10kV。

TM10-320C low-voltage surge protector is applicable for the surge protection of lighting power supplies, such as outdoor street lamps, landscape lights, traffic signals and so on . It is used to suppress and discharge the overcurrent and overvoltage generated by induction lightning or low-voltage distribution systems, and protect electrical equipment from damage. This product is suitable for 110V-277V AC power supply system, using full-mode protection, using soft wire and external circuit parallel connection.

Surge protection level:

IEC/EN 61643-11 Nominal discharge current 5kA, Maximum discharge current 10kA , Impulse open circuit voltage 10kV.

GB/T18802.11-2020 Nominal discharge current 5kA, Maximum discharge current 10kA, Impulse open circuit voltage 10kV.

2. 术语 Glossary

2.1 浪涌 Surge

电路中电流、电势或能量的瞬态波。基于本标准，浪涌不包括在几个周期内因升高的工频电压所产生的瞬态过电压（TOV）。

A transient wave of current, potential or power in an electric circuit. For the purposes of this standard, surges do not include temporary over voltages (TOV) consisting of an increase in the power frequency voltage for several cycles.

2.2 电涌保护器 Surge Protective Device (SPD)

至少包含一个非线性元件，通过转移或抑制冲击电流来限制冲击电压的设备，且可以重复使用。

A device composed of at least one non-linear component and intended for limiting surge voltages on equipment by diverting or limiting surge current and is capable of repeating these functions as specified.

2.3 状态指示器 Status Indicator

指示 SPD 或者 SPD 一个部件工作状态的设备。

Device that indicates the operational status of an SPD, or a part of an SPD.

2.4 1.2/50 μ s 电压波形 1.2/50 μ s Voltage Wave

在开路情况下，视在波前时间为 1.2 μ s，且半峰值时间为 50 μ s 的冲击电压。

Voltage surge with a virtual front time of 1.2 μ s and a time to half-value of 50 μ s delivered across an open circuit.

2.5 8/20 μ s 电流波形 8/20 μ s Current Wave

短路情况下，视在波前时间为 8 μ s 且半峰值时间为 20 μ s 的冲击电流。

Current surge with a virtual front time of 8 μ s and a time to half-value of 20 μ s delivered into a short circuit.

- 2.6 标称系统电压 Nominal System Voltage
参照 ANSI C84.1 表 1, 指定系统电压等级所对应的标称值。
A nominal value assigned to designate a system of a given voltage class in accordance with ANSI C84.1, Table 1.
- 2.7 最大持续工作电压 Maximum Continuous Operating Voltage (MCOV)
可连续地施加在 SPD 上的最大交流电压有效值或直流电压。
Maximum r.m.s. voltage, which may be continuously applied to the SPD's mode of protection.
- 2.8 实测限制电压 Measured Limiting Voltage (MLV)
施加规定波形和幅值的冲击时, 在 SPD 端子处测得最大电压峰值。
Highest value of voltage that is measured across the terminals of the SPD during the application of impulses of specified wave shape and amplitude.
- 2.9 电压保护水平 Voltage Protection Level (U_p)
由于施加规定陡度的冲击电压和规定幅值及波形的冲击电流而在 SPD 两端之间预期出现的最大电压。
Maximum voltage to be expected at the SPD terminals due to an impulse stress with defined voltage steepness and an impulse stress with a discharge current with given amplitude and wave shape.
- 2.10 参考试验电压 Reference Test Voltage (U_{REF})
用于 SPD 测试的电压有效值。它取决于 SPD 的保护模式、系统标称电压、系统结构和系统内的电压调整。
The r.m.s. value of voltage used for testing which depends on the mode of protection of the SPD, the nominal system voltage, the system configuration and the voltage regulation within the system.
- 2.11 标称放电电流 Nominal Discharge Current (I_n)
由厂家给出的, SPD 在经过 15 次 8/20 μ s 电流波形浪涌冲击后无损坏的电流峰值。
Peak value of the current, selected by the manufacturer, through the SPD having a current wave shape of 8/20 μ s where the SPD remains functional after 15 surges.
- 2.12 最大放电电流 Maximum Discharge Current (I_{max})
流过 SPD, 具有为 8/20 μ s 波形电流的峰值, 其峰值大小由厂家规定。 I_{max} 等于或大于 I_n 。
Crest value of a current through the SPD having an 8/20 μ s wave shape and magnitude according to the manufacturers specification. I_{max} is equal to or greater than I_n .
- 2.13 保护模式 Modes of Protection
在端子间保护保护元器件的电流路径, 例如相对相、相对地、相对中线、中线对地。

An intended current path, between terminals that contains protective components, e.g. line-to-line, line-to-earth, line-to-neutral, neutral-to-earth.

2.14 热稳定 Thermal Stability

在引起 SPD 温度上升的动作负载试验后，在规定的环境温度条件下，给 SPD 施加规定的最大持续工作电压，如果 SPD 的温度能随时间而下降，则认为 SPD 是热稳定的。

SPD is thermally stable if, after heating up during the operating duty test, its temperature decreases with time while energized at specified maximum continuous operating voltage and at specified ambient temperature conditions.

2.15 外壳防护等级 (IP 代码) Degrees of Protection Provided by Enclosure (IP code)

外壳提供的防止触及危险的部件、防止外界固体异物进入和或防止水的进入壳内的防护程度。

Classification preceded by the symbol IP indicating the extent of protection provided by an enclosure against access to hazardous parts, against ingress of solid foreign objects and possibly harmful ingress of water.

2.16 开路电压 Open Circuit Voltage (Uoc)

在复合波发生器连接试品端口处的开路电压。

Open circuit voltage of the combination wave generator at the point of connection of the device under test.

3. 结构尺寸 Structure and Dimensions

3.1 结构图 Structure

产品结构：该产品设计类型为复合型，带工作状态指示，黑色外壳，黑色环氧灌封胶。采用的电源线和外电路并连。

Product Structure: The design type of this product is compound, with working status indication, black shell, and black epoxy potting glue. It uses power cord and external circuit parallel connection.

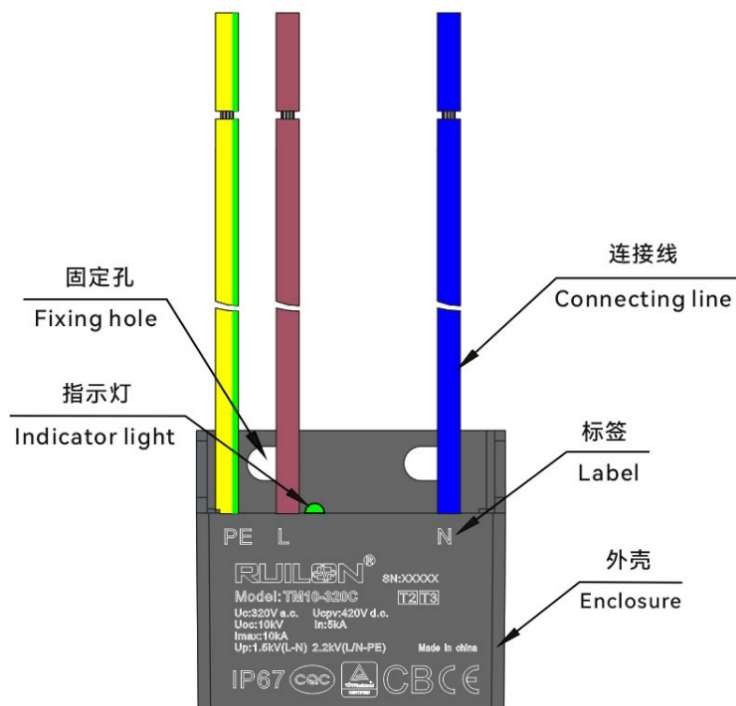

3.2 主要原材料明细 Main Material List

编号 NO.	零件名 Part Name	材质 Materials
1	外壳 Enclosure	塑料 Plastic
2	连接线 Connecting line	铜、塑料 Copper、Plastic
3	陶瓷气体放电管 Gas Discharge Tubes	陶瓷、铜 Ceramics、Cu
4	压敏电阻 Varistor	氧化锌 Zinc Oxide
5	温度保险丝 Thermal Fuse	合金型 Alloy-Type
6	灌封材料 Embedding Material	环氧树脂 Epoxy Resin

3.3 产品尺寸 Product Dimensions

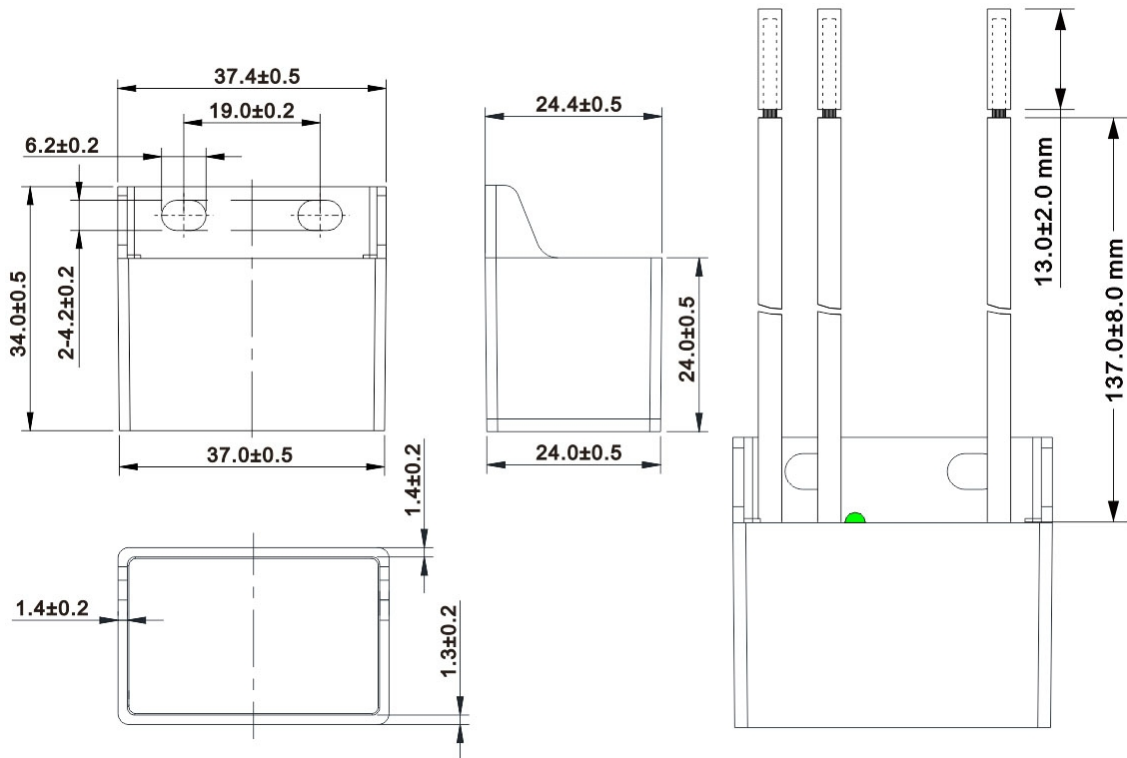

单位 Unit: mm

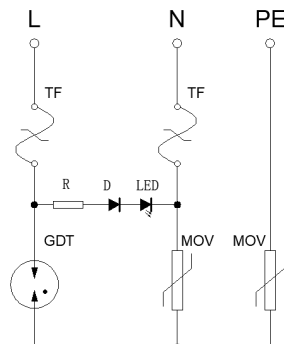

3.4 电路图 Circuit Diagram



4. 安规认证 Agency Approvals

认证标志 Agency	标准 Standards	认证号 File No.	类别 Category
	GB/T 18802.11-2020	CQC23123373130	Type 2+ Type 3
CB	IEC 61643-11:2011	HU-004206	Type 2+ Type 3
CE	EN 61643-11:2012+A11	AN 50569398 0001	Type 2+ Type 3
	EN 61643-11:2012+A11	R50568140	Type 2+ Type 3

5. 环保 Environment

环保 Environment	指令号 Order No.	指令 Order
RoHS	2015/863/EU	满足 RoHS 指令 Meet the RoHS

6. 技术参数 Specifications

技术特性 Technical Feature	技术参数 Technical Parameters	执行标准 Reference Standards
工作温度 Operational Temperature Range	(-40 -85)°C	GB/T 10193 IEC 61051
极限存储温度及湿度(24 小时) Storage Temperature and Humidity Range (24 hours)	(-40 -100)°C ≤95%RH	IEC 60068-2-1 IEC 60068-2-2
最大持续工作电压 Max. Continuous Operating Voltage (U _c)	320 V a.c.	IEC 61643-11
标称放电电流 Nominal Discharge Current(I _n) (8/20 μs)	5kA	IEC 61643-11
最大放电电流 Maximum Discharge Current(I _{max})(8/20 μs)	10kA	IEC 61643-11
开路电压 Open Circuit Voltage (U _{oc})	10kV	IEC 61643-11
电压保护水平 Voltage Protection Level (U _p)	1.5kV (L-N) 2.2kV (L/N-PE)	IEC 61643-11
状态指示 Status Indication	正常: 绿色; 失效: 灯灭 Normal:green Fault: lights go out	/
防护等级 Degrees of Protection Provided by Enclosure	IP67	IEC 60529
海拔 Altitude	-500m to 4000 m	/

7. 检验方法和标准 Inspection Method & Standards

7.1 常规检验项目 General Test Items

序号 No.	项目 Items	检验工具 Inspection Tools	检验要求 Inspection Requirement	参考标准 Reference Standards
1	外观 Appearance	目视 Visual check	外壳无穿孔、无飞边、标示清晰。 The case without perforation and fins, the mark is clear.	企业标准 Enterprise Standard
2	尺寸 Dimension	游标卡尺 vernier caliper	用游标卡尺测量产品尺寸，尺寸范围 3.3。 Use the Vernier caliper to measure the product size, and the size range please reference to the table 3.3.	企业标准 Enterprise Standard

7.2 电压保护等级测试 Voltage Protect Rating Test

参考标准: IEC61643-11-2011 章节 8.3.3.3

Reference Standard: IEC61643.11-2011 Section 8.3.3.3.

测试方法:

使用复合波进行本试验(Test:L-N,L-PE,N-PE)

- 1) 每次冲击的间隔时间应足以使试品冷却到环境温度。
- 2) 设定复合波发生器的电压，使输出的开路电压未制造商对 SPD 规定 U_{oc} 的 0.1,0.2,0.5 和 1.0 倍。
- 3) 用上述这些发生器的整定值，每种幅值对 SPD 施加 4 次冲击，正负极性各 2 次。
- 4) 每次冲击时，应用示波器记录从发生器流入 SPD 的电流和在 SPD 输出端口的电压。
- 5) 测得的限制电压和 U_{max} 是在整体试验程序中记录的最大放电电压。

Test Method:

To perform this test a combination wave generator is used.

- 1) The interval between the individual impulses shall be long enough for the sample to cool down to ambient temperature.
- 2) The voltage of the combination wave generator is set to provide an open-circuit voltage of 0,1; 0,2; 0,5; 1,0 times the U_{oc} as declared by the manufacturer for the SPD.
- 3) With these generator settings four surges will be applied to the SPD at each amplitude: two with positive and two with negative polarity.
- 4) An oscillographic record shall be made of the current delivered by the generator into the SPD and the voltage at the output port of the SPD for each impulse.
- 5) The value for determining the measured limiting voltage and U_{max} is the maximum voltage recorded during this test.

判定标准:

试验中，电压和电流波形图及目测检查试品没有击穿或闪络的迹象。

对于二类试验，测试样品的限制电压即为 $U_{max}(8/20\mu s)$ 和 U_{max} (波前放电电压)的最大值；对于三类试验，测试样品的限制电压即为 U_{max} (混合波)。上述测试的限制电压值小于等于标注的电压保护水平。

Pass criteria:

During the test, there was no evidence of breakdown or flashover on the voltage and current waveforms and visual inspection of the samples.

For the second type test, the limiting voltage of the test sample is the maximum value of U_{max} (8/20 μ s) and U_{max} (wavefront discharge voltage); for the third type test, the limiting voltage of the test sample is U_{max} (mixed wave). The limit voltage value of the above test is less than or equal to the marked voltage protection level.

7.3 标称放电电流试验 Nominal Discharge Current Test

参考标准: IEC61643-11-2011 章节 8.3.4.3

Reference Standard: IEC61643.11-2011 Section 8.3.4.3.

测试方法:

- 1) 对试品 L-N 施加 15 次 8/20 正极性的冲击电流, 分成 3 组, 每组 5 次冲击。每次冲击与电源频率同步, 同步角以 $30^{\circ}\pm 5^{\circ}$ 的间隔逐级增加, 每次冲击记录电流波形; 每次冲击的同时施加 U_c , 两次冲击之间的间隔时间为 50-60s。
- 2) 两组之间的间隔时间为 30min-35min。
- 3) 15 次冲击结束后, 保持 U_c 时间不少于 15 分钟。
- 4) 重复上述步骤 1)~ 3) 重复 3 次。
- 5) L-PE、N-PE 重复上述步骤。

Test Method:

- 1) Apply an impulse current of 8/20 positive polarity to the test samples L-N 15 times, and divide them into 3 groups with 5 impulses in each group. Each shock is synchronized with the power frequency, the synchronization angle increases step by step at intervals of $30^{\circ}\pm 5^{\circ}$, and the current waveform is recorded for each shock. Apply U_c at the same time as each impact, The interval between two shocks is 50-60s.
- 2) The interval between two groups is 30min-35min.
- 3) Impact 15 shocks, keep U_c for no less than 15 minutes.
- 4) Steps 1) and 3), above, shall be repeated for a total of 3 cycles.
- 5) Repeat the above test at L-PE, N-PE.

判定标准:

- 1) 产品应达到热稳定。在施加 U_c 电压的最后 15min, 如果电流 I_c 的阻性分量峰值或功耗呈现出下降的趋势或没有升高, 则认为 SPD 是热稳定的。如果试验本身是加电 U_c 进行的, 则不间断地继续保持加电 15min, 或在 30s 内重新加电。
- 2) 电压和电流波形图及目测检查应没有击穿或闪络的迹象。
- 3) 试验过程中无发生可见的损坏。
- 4) 试验后所测量的限制电压应小于或等于 U_p 。
- 5) 试验后, 不得有过高的泄漏电流。SPD 根据制造商的说明书按正常使用连接到参考试验电压 U_{REF} 的电源, 测量流过每个端子的电流, 电流的阻性分量不得超过 1mA, 或者电流增加不得超过在相关试验初始时测量结果的 20%。
- 6) 试验时, 制造商规定的外部脱离器不得动作; 试验后, 该脱离器处在正常工作状态。
- 7) 试验时, 制造商规定的内部脱离器不得动作; 试验后, 该脱离器处于正常工作状态。
- 8) 不得有对人员或者设备产生的爆炸或其他危险。

Pass Criteria:

- 1) Thermal stability shall be achieved. The SPD is considered to be thermally stable if the crest of the resistive component of the current flowing into the SPD or the power dissipation shows either a decreasing tendency or does not increase during 15 min of U_c voltage application immediately after the application of U_c . If the test itself is performed with the SPD energized at U_c , then U_c either remains applied for these 15 min without interruption or is reapplied within less than 30 s.
- 2) Voltage and current records and visual inspection shall show no indication of puncture or flashover.
- 3) No visible damage shall occur during the test.
- 4) Values for measured limiting voltage after the test shall be below or equal to U_p .
- 5) No excessive leakage currents shall occur after the test; The SPD shall be connected as for normal use according to the manufacturer's instructions to a power supply at the reference test voltage (U_{REF}). The current that flows through each terminal is measured. Its resistive component (measured at the crest of the sine wave) shall not exceed a value of 1 mA, or the current shall not have changed by more than 20% compared to the initial value determined at the beginning of the relevant test sequence.
- 6) External disconnectors as specified by the manufacturer shall not operate during the test and shall be in working order after the test.
- 7) Internal disconnectors as specified by the manufacturer shall not operate during the test and shall be in working order after the test.
- 8) There shall be no explosion or other hazard to either personnel or the facility.

8. 安全预防措施 Safety Precautions

8.1 安装前阅读并理解所有说明。

Read and understand all instructions before installation.

8.2 持续施加在产品上的电压不应超过其最大连续工作电压 U_c 。

The voltage continuously applied to the product should not exceed its maximum continuous working voltage U_c

8.3 装配时不要用丙酮等溶剂清洗本产品，以免破坏本产品的封装层。

Avoiding to destroy enclosure, solvent such as acetone is forbidden for cleaning products when assembly.

8.4 装配时应避免出现如敲击等作业方式，避免造成本产品出现机械损伤。

Avoiding making mechanical damage on products, improper operation such as knocking when assembly is not allowed.

8.5 应用本产品的设备必须有可靠的接地线与大地相连，地线长度应小于 0.5 米。

Equipment on the use of the products must have reliable grounding to the earth, the length of the grounding wire less than 0.5 m.

- 8.6 未遵守操作说明可能导致电气系统或相关设备损坏。
If you do not obey the instructions, the electric system or associated equipment may be breakdown.
- 8.7 安装位置: 室内/室外。
Installation location: Indoors/Outdoors.
- 8.8 系统电压波动范围小于 10%。
Fluctuation range of system voltage shall be less than 10%.
- 8.9 如果 SPD 老化失效, 热保护装置断开, 工作指示灯熄灭, 应立即更换。
The SPD should be replaced immediately when it has the problem of aging failure which would cause the thermal protection device disconnect and the work indicator lights turn off.
- 8.10 安装方式 Mounting Method
采用电源线与被保护设备并联连接。
It employs the parallel connection of the protected device and power cord.

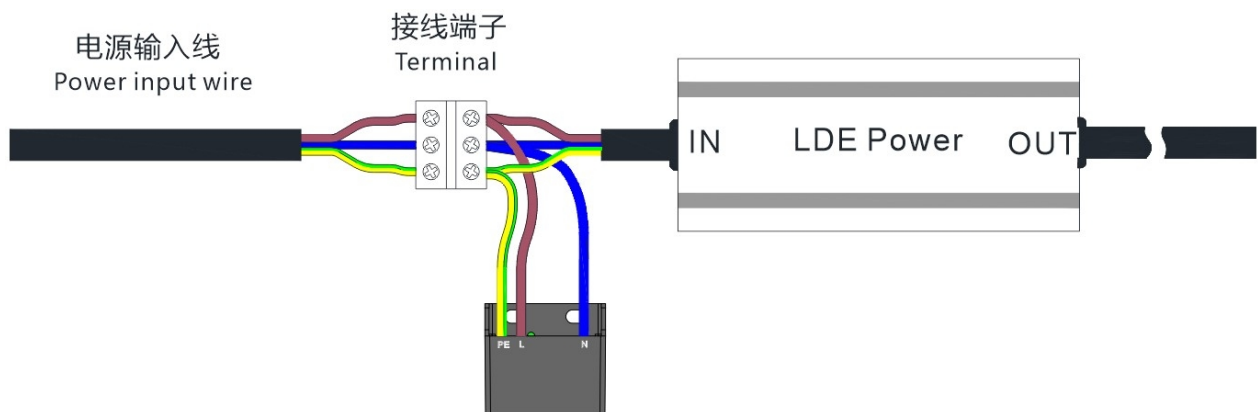

- 注: 1、SPD 的 PE 线应与整机的接地端子连接。
The PE line of SPD should be connected with the earthing terminal of the whole machine.
- 2、如电源输入线缆设置有 PE 线, PE 线应与金属安装板或与整机的接地端子连接。
If the power input cable is provided with PE wire, the PE wire shall be connected with the metal mounting plate or with the grounding terminal of the whole machine.

9. 标示及包装 Marks and Package

9.1 产品本体标示 Marking on Product

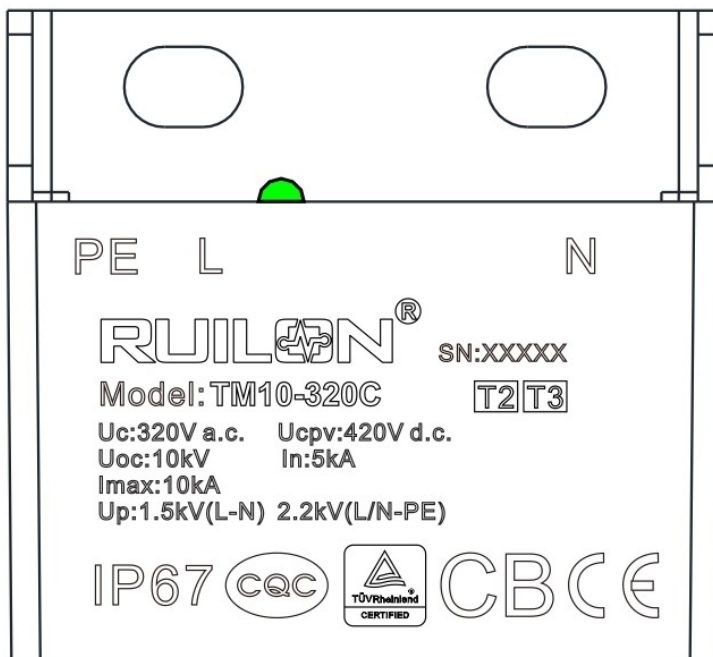

9.2 包装 Packaging

包装方式与要求
Packaging Method and Requirement

包装尺寸(mm) Dimensions	内盒 Inner Box 382*253*31	外箱 Carton 395*267*285
数量 (PCS) Quantity	16	160
净重(kg) Net Weight	≈0.712	≈7.12
毛重(kg) Gross Weight	≈0.79	≈8.3

备注:

Remark:

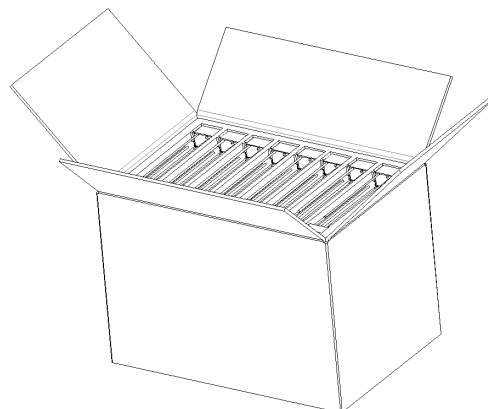
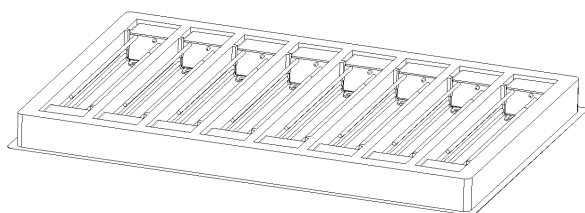

10. 产品批号&追溯号识别 Lot No. & Tracking No. System

大包装追溯号:
Tracking No. on the Outer Package:

Product code(产品代码)	10.20.25.3201-1001
Lot No(批次)	生产批次 Production batch
Product number(产品型号)	TM10-320C
Quantity (数量)	160



11. 储存条件和有效日期 Storage Conditions and Effective Date

- a) 推荐长期存储条件: 存储温度: (-10 - 40) °C, 存储湿度: ≤75%RH。
Recommend Long-term Storage Condition: Storage Temperature: (-10 - 40) °C, Storage Humidity ≤75%RH.
- b) 不要将本产品存放在有腐蚀性气体或阳光直接照射的环境中。
Do not store the products in the environment that with corrosive gas or under direct sunlight.
- c) 存储期限: 2 年。
Storage Period: 2 years.

12. 有效性 Validity

12.1 修订协议 Agreement of Revision

本规格书的内容若有不充分或需要修订时, 得由两公司协议后再行修订。
If the content of the specifications is inadequate or need revising, it will be revised after agreement by both parties.

12.2 有效性 Validity

本规格书提出后, 于贵公司承认期间, 可暂时使用, 若经过 1 个月后贵公司无异议或未签回规格书时, 则视同有效文件运用。

The specifications can be used temporarily during the period of approval. If you have no any objection or not return one hardcopy to us within 1 month, the specifications will be operated as a valid document.

-以下无正文 END-