

深圳市瑞隆源电子有限公司 Shenzhen RUILONGYUAN Electronics Co.,Ltd.			
产品名称 Product name	低压电涌保护器 Low-voltage Surge Protective Devices	产品型号 Product type	TP10E
文件编号 File serial number	SP-SPD-076	产品编码 Product code	10.20.31.3204-0002
类别 Classification	<input type="checkbox"/> 参考阶段 Reference <input type="checkbox"/> 正式承认 Qualified	<input type="checkbox"/> 样品阶段 Sample <input checked="" type="checkbox"/> 工程变更 Changed	

TP10E

低压电涌保护器 技术规格书

Low-voltage Surge Protective Device Technical Specification

拟制:	Lucy	日期:	2024.09.10
Prepared by	_____	Date	_____
审核:	Jim	日期:	2024.09.10
Reviewed by	_____	Date	_____
批准:	Robert	日期:	2024.09.10
Approved by	_____	Date	_____

深圳市瑞隆源电子有限公司

Shenzhen RUILONGYUAN Electronics Co.,Ltd.

版权所有 侵权必究

All rights reserved

修订记录 Revision History

版本 Revision Version	描述 Description	页码 Page	日期 Date
X0	参考阶段 Reference	14	2022.10.25
A0	正式承认 Qualified	14	2023.03.15
A1	工程变更 Changed	14	2023.05.17
A2	工程变更 Changed	14	2023.06.14
A3	工程变更 Changed	14	2023.08.15
A4	3.3 产品尺寸更新 Product size updates	14	2024.09.10

目录 Catalogue

1.适用范围 Scope	4
2.术语 Glossary.....	4
3.结构尺寸 Structure and Dimensions	6
3.1 结构图 Structure	6
3.2 主要原材料明细 Main Material List.....	7
3.3 产品尺寸 Product Dimensions.....	7
3.4 电路图 Circuit Diagram.....	7
4.安规认证 Agency Approvals	8
5.环保 Environment.....	8
6.技术参数 Specifications.....	8
7.检验方法和标准 Inspection Method & Standards	9
8.安全预防措施 Safety Precautions	11
9.标示及包装 Marks and Package	13
10.产品批号&追溯号识别 Lot No. & Tracking No. System.....	13
11.储存条件和有效日期 Storage Conditions and Effective Date.....	14
12.有效性 Validity	14
12.1 修订协议 Agreement of Revision	14
12.2 有效性 Validity.....	14

1. 适用范围 Scope

TP10E 低压电涌保护器应用于户外路灯、景观灯、交通信号灯等照明电源的电涌保护，抑制和泄放因感应雷或低压配电系统内部所产生的过电流和过电压，保护用电设备免受损害。本产品适用于 100V-277V 的交流供电系统，采用全模式的保护方式，使用软导线与外电路并联连接。

浪涌防护等级：

IEC/EN 61643-11 标称放电电流 5kA，最大放电电流 10kA，开路电压 10kV；
 GB/T18802.11-2020 标称放电电流 5kA，最大放电电流 10kA，开路电压 10kV；
 UL1449 标称放电电流 5kA。

TP10E low-voltage surge protector is applicable for the surge protection of lighting power supplies, such as outdoor street lamps, landscape lights, traffic signals and so on . It is used to suppress and discharge the overcurrent and overvoltage generated by induction lightning or low-voltage distribution systems, and protect electrical equipment from damage. This product is suitable for 100V-277V AC power supply system, using full-mode protection, using soft wire and external circuit parallel connection.

Surge protection level:

IEC/EN 61643-11 Nominal discharge current 5kA, Maximum discharge current 10kA, Impulse open circuit voltage 10kV;
 GB/T18802.11-2020 Nominal discharge current 5kA, Maximum discharge current 10kA, Impulse open circuit voltage 10kV;
 UL1449 Nominal discharge current 5kA.

2. 术语 Glossary

2.1 浪涌 Surge

电路中电流、电势或能量的瞬态波。基于本标准，浪涌不包括在几个周期内因升高的工频电压所产生的瞬态过电压 (TOV)。

A transient wave of current, potential or power in an electric circuit. For the purposes of this standard, surges do not include temporary over voltages (TOV) consisting of an increase in the power frequency voltage for several cycles.

2.2 电涌保护器 Surge Protective Device (SPD)

至少包含一个非线性元件，通过转移或抑制冲击电流来限制冲击电压的设备，且可以重复使用。

A device composed of at least one non-linear component and intended for limiting surge voltages on equipment by diverting or limiting surge current and is capable of repeating these functions as specified.

2.3 状态指示器 Status Indicator

指示 SPD 或者 SPD 一个部件工作状态的设备。

Device that indicates the operational status of an SPD, or a part of an SPD.

2.4 1.2/50 μs 电压波形 1.2/50 μs Voltage Wave

在开路情况下，视在波前时间为 1.2 μs，且半峰值时间为 50 μs 的冲击电压。

Voltage surge with a virtual front time of 1.2 μs and a time to half-value of 50 μs delivered across an open circuit.

- 2.5 8/20 μs 电流波形 8/20 μs Current Wave
短路情况下，视在波前时间为 8 μs 且半峰值时间为 20 μs 的冲击电流。
Current surge with a virtual front time of 8 μs and a time to half-value of 20 μs delivered into a short circuit.
- 2.6 标称系统电压 Nominal System Voltage
参照 ANSI C84.1 表 1，指定系统电压等级所对应的标称值。
A nominal value assigned to designate a system of a given voltage class in accordance with ANSI C84.1, Table 1.
- 2.7 最大持续工作电压 Maximum Continuous Operating Voltage (MCOV)
可连续地施加在 SPD 上的最大交流电压有效值或直流电压。
Maximum r.m.s. voltage, which may be continuously applied to the SPD's mode of protection.
- 2.8 实测限制电压 Measured Limiting Voltage (MLV)
施加规定波形和幅值的冲击时，在 SPD 端子处测得最大电压峰值。
Highest value of voltage that is measured across the terminals of the SPD during the application of impulses of specified wave shape and amplitude.
- 2.9 电压保护水平 Voltage Protection Level (Up)
由于施加规定陡度的冲击电压和规定幅值及波形的冲击电流而在 SPD 两端之间预期出现的最大电压。
Maximum voltage to be expected at the SPD terminals due to an impulse stress with defined voltage steepness and an impulse stress with a discharge current with given amplitude and wave shape.
- 2.10 参考试验电压 Reference Test Voltage (U_{REF})
用于 SPD 测试的电压有效值。它取决于 SPD 的保护模式、系统标称电压、系统结构和系统内的电压调整。
The r.m.s. value of voltage used for testing which depends on the mode of protection of the SPD, the nominal system voltage, the system configuration and the voltage regulation within the system.
- 2.11 标称放电电流 Nominal Discharge Current (I_n)
由厂家给出的，SPD 在经过 15 次 8/20 μs 电流波形浪涌冲击后无损坏的电流峰值。
Peak value of the current, selected by the manufacturer, through the SPD having a current wave shape of 8/20 μs where the SPD remains functional after 15 surges.
- 2.12 最大放电电流 Maximum Discharge Current (I_{max})
流过 SPD，具有为 8/20 μs 波形电流的峰值，其峰值大小由厂家规定。 I_{max} 等于或大于 I_n 。
Crest value of a current through the SPD having an 8/20 μs wave shape and magnitude according to the manufacturers specification. I_{max} is equal to or greater than I_n .

2.13 保护模式 Modes of Protection

在端子间保护保护元器件的电流路径，例如相对相、相对地、相对中线、中线对地。

An intended current path, between terminals that contains protective components, e.g. line-to-line, line-to-earth, line-to-neutral, neutral-to-earth.

2.14 热稳定 Thermal Stability

在引起 SPD 温度上升的动作负载试验后，在规定的环境温度条件下，给 SPD 施加规定的最大持续工作电压，如果 SPD 的温度能随时间而下降，则认为 SPD 是热稳定的。

SPD is thermally stable if, after heating up during the operating duty test, its temperature decreases with time while energized at specified maximum continuous operating voltage and at specified ambient temperature conditions.

2.15 外壳防护等级（IP 代码）Degrees of Protection Provided by Enclosure (IP code)

外壳提供的防止触及危险的部件、防止外界固体异物进入和或防止水的进入壳内的防护程度。

Classification preceded by the symbol IP indicating the extent of protection provided by an enclosure against access to hazardous parts, against ingress of solid foreign objects and possibly harmful ingress of water.

2.16 开路电压 Open Circuit Voltage (Uoc)

在复合波发生器连接试品端口处的开路电压。

Open circuit voltage of the combination wave generator at the point of connection of the device under test.

3. 结构尺寸 Structure and Dimensions

3.1 结构图 Structure

产品结构：该产品设计类型为复合型，带工作状态指示，黑色外壳，黑色环氧灌密封胶。采用的电源线和外电路并连。

Product Structure: The design type of this product is compound, with working status indication, black shell, and black epoxy potting glue. It uses power cord and external circuit parallel connection.

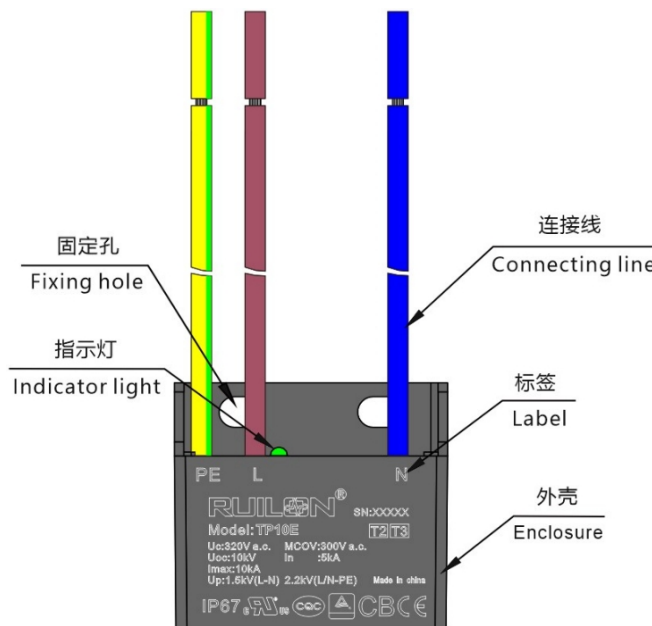

3.2 主要原材料明细 Main Material List

编号 NO.	零件名 Part Name	材质 Materials
1	外壳 Enclosure	塑料 Plastic
2	连接线 Connecting line	铜、塑料 Copper、Plastic
3	陶瓷气体放电管 Gas Discharge Tubes	陶瓷、铜 Ceramics、Cu
4	压敏电阻 Varistor	氧化锌 Zinc Oxide
5	温度保险丝 Thermal Fuse	合金型 Alloy-Type
6	灌封材料 Embedding Material	环氧树脂 Epoxy Resin



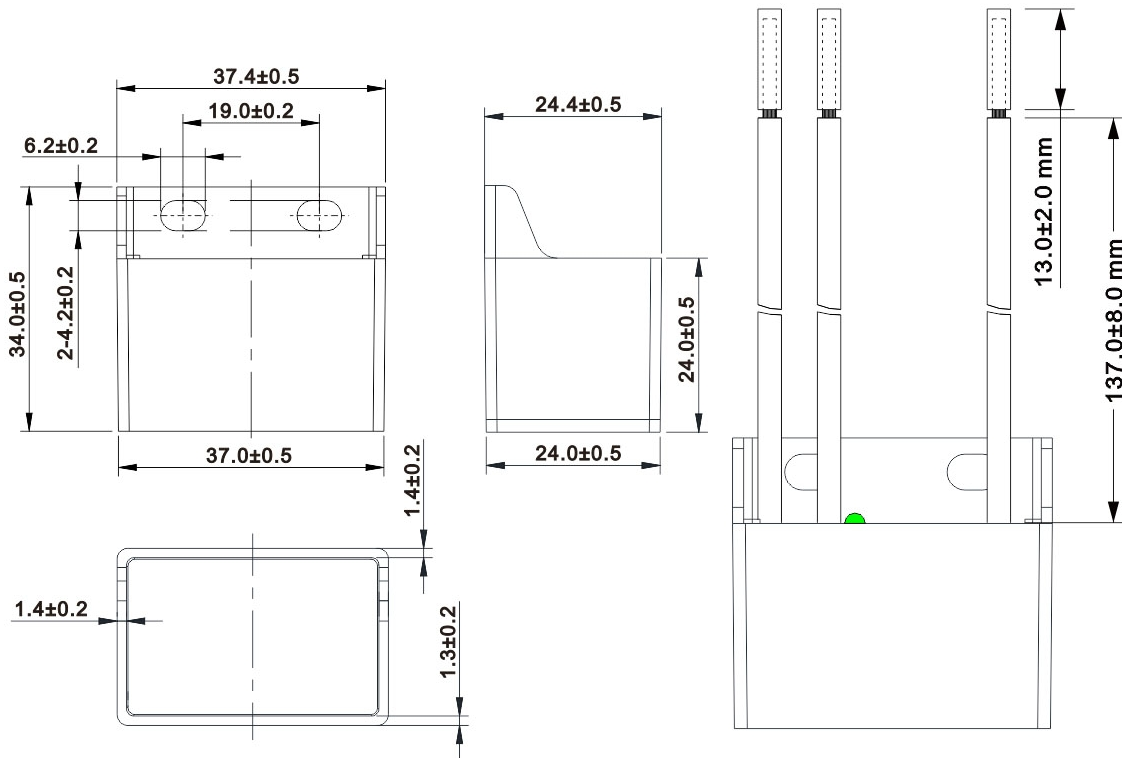

3.3 产品尺寸 Product Dimensions 单位 Unit: mm

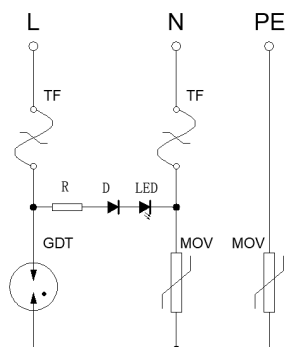

3.4 电路图 Circuit Diagram



4. 安规认证 Agency Approvals

认证标志 Agency	标准 Standards	认证号 File No.	类别 Category
	UL1449	E508408	Type 5
	GB/T 18802.11-2020	CQC23123373130	Type 2+ Type 3
CB	IEC 61643-11:2011	HU-004206	Type 2+ Type 3
	EN 61643-11:2012+A11	AN 50569398 0001	Type 2+ Type 3
	EN 61643-11:2012+A11	R50568140	Type 2+ Type 3

5. 环保 Environment

环保 Environment	指令号 Order No.	指令 Order
RoHS	2015/863/EU	满足 RoHS 指令 Meet the RoHS

6. 技术参数 Specifications

技术特性 Technical Feature	技术参数 Technical Parameters	执行标准 Reference Standards
工作温度 Operational Temperature Range	(-40 -85)°C	GB/T 10193 IEC 61051
极限存储温度及湿度 (24 小时) Storage Temperature and Humidity Range (24 hours)	(-40 -100)°C ≤95%RH	IEC 60068-2-1 IEC 60068-2-2
最大持续工作电压 Max. Continuous Operating Voltage (U _c)	320 V a.c.	IEC61643-11
最大连续工作电压 Max. Continuous Operating Voltage(MCOV)	300 V a.c.	UL1449
标称放电电流 Nominal Discharge Current(I _n) (8/20 μs)	5kA	IEC61643-11
最大放电电流 Maximum Discharge Current(I _{max})(8/20 μs)	10kA	IEC61643-11
开路电压 Open Circuit Voltage (U _{oc})	10kV	IEC61643-11
电压保护水平 Voltage Protection Level (U _p)	1.5kV (L-N) 2.2kV (L/N-PE)	IEC61643-11
状态指示 Status Indication	正常: 绿色; 失效: 灯灭 Normal:green Fault: lights go out	/
防护等级 Degrees of Protection Provided by Enclosure	IP67	UL 50E
海拔 Altitude	-500m to 4000 m	/

7. 检验方法和标准 Inspection Method & Standards

7.1 常规检验项目 General Test Items

序号 No.	项目 Items	检验工具 Inspection Tools	检验要求 Inspection Requirement	参考标准 Reference Standards
1	外观 Appearance	目视 Visual check	外壳无穿孔、无飞边、标示清晰。 The case without perforation and fins, the mark is clear.	企业标准 Enterprise Standard
2	尺寸 Dimension	游标卡尺 vernier caliper	用游标卡尺测量产品尺寸，尺寸范围 3.3。 Use the Vernier caliper to measure the product size, and the size range please reference to the table 3.3.	企业标准 Enterprise Standard

7.2 初始电压保护等级测试 Initial Voltage Protect Rating Test

参考标准: UL 1449 第五版本 章节 41.6

Reference Standard: UL 1449 5th Section 41.6.

测试方法:

在试品两端施加 MCOV,在相位角 90°下施加 3 次 6kV/3kA 的冲击,记录测量电压和电流波形;

Test Method:

Apply MCOV to both ends of the test sample, apply 6kV/3kA impulses 3 times at a phase angle of 90° degrees,Record the wave shape of the voltage and current.

判定标准:

- 1) 不能发出火焰, 熔化金属, 或通过产品上的任何孔隙有炽热或燃着的小颗粒溅出。
- 2) 不能使支撑面、薄纸或者纱布碳化或起火。
- 3) 不能在外壳上造成开孔, 使导电部件可以被触及。
- 4) 内部或外部的脱离器不应动作, 试验结束后应处于正常工作状态。
- 5) 每个测量值不能超过 VPR 的 10%。

Pass criteria:

- 1) No flaming melting metal or other scalding or burning granule spilling out from the enclosure.
- 2) No carbonizing or igniting the bearing surface, thin paper or gauze.
- 3) No making a hole on the enclosure to let the conducting part can be touched.
- 4) Internal or external disconnectors shall not operate during the test and shall be in working order after the test.
- 5) No individual measured limiting voltage may exceed the voltage protection rating by 10% percent.

7.3 标称放电电流试验 Nominal Discharge Current Test

参考标准: UL 1449 第五版本 章节 42.1

Reference Standard: UL 1449 5th Section 42.1.

测试方法:

- 1) 未通电下, 在产品两端施加 8/20 μs 的电流冲击 In, 并记录测得的限制电压。

- 2) 在 1 秒内在产品两端加上 MCOV, 持续时间 60 秒。
- 3) 上述步骤 1)、2)重复 5 次。
- 4) 每组期间样品休息 30 分钟 (5 次为一组, 共三组)。
- 5) 重复上述步骤 1)~ 4)重复 3 次。
- 6) 15 次冲击结束后, 样品测试脚间施加 MCOV 时间不少于 15 分钟。

Test Method:

- 1) While the sample is unenergized, apply the 8/20 μ s current surge both ends, at the Nominal Discharge Current specified through the sample. The limiting voltage that results from the impulse shall be measured and recorded after application of the specified surge.
- 2) Within 1 second following the previous surge application, the MCOV shall be applied for 60 seconds.
- 3) Steps 1) and 2), above, shall be repeated for a total of 5 cycles.
- 4) The samples shall be allowed to rest for 30 minutes, five impulses as a group, three groups total.
- 5) Steps 1) through 4), above, shall be repeated for a total of 3 cycles.
- 6) Following the 15th surge, the MCOV shall be re-applied for at least 15 minutes.

判定标准:

- 1) 不能发出火焰、熔化金属, 或通过产品上的任何孔隙有炽热或燃着的小颗粒溅出。
- 2) 不能使支撑面、薄纸或者纱布碳化或起火。
- 3) 外壳不应起火。
- 4) 不能在外壳上造成开孔, 导致导电部件被触及。
- 5) 内部或外部的脱离器不应动作, 试验结束后应处于正常工作状态。

Pass Criteria:

- 1) No flaming, melting metal or other scalding or burning granule spilling out from the enclosure.
- 2) No carbonizing or igniting the bearing surface, thin paper or gauze.
- 3) The enclosure shall not catch fire.
- 4) No openings were created in the enclosure that resulted in the accessibility of live parts.
- 5) Internal or external disconnectors shall not operate during the test and shall be in working order after the test.

7.4 重复电压保护等级测试 Repeated Voltage Protection Rating Test

参考标准: UL 1449 第五版本 章节 41.9

Reference Standard: UL 1449 4th Section 41.9.

测试方法:

在试品两端施加 MCOV,在相位角 90°下施加 3 次 6kV/3kA 的冲击,记录测量电压和电流波形。

Test Method:

Apply MCOV to both ends of the test sample, apply 6kV/3kA impulses 3 times at a phase angle of 90° degrees, Record the wave shape of the voltage and current.

判定标准:

- 1) 不能发出火焰, 熔化金属, 或通过产品上的任何孔隙有炽热或燃着的小颗粒溅出。
- 2) 不能使支撑面、薄纸或者纱布碳化或起火。
- 3) 不能在外壳上造成开孔, 使导电部件可以被触及。
- 4) 内部或外部的脱离器不应动作, 试验结束后应处于正常工作状态。
- 5) 每个测量值不能超过 VPR 的 10%。

Pass criteria:

- 1) No flaming, melting metal or other scalding or burning granule spilling out from the enclosure,
- 2) No carbonizing or igniting the bearing surface, thin paper or gauze,
- 3) No making a hole on the enclosure to let the conducting part can be touched,
- 4) Internal or external disconnectors shall not operate during the test and shall be in working order after the test,
- 5) No individual measured limiting voltage may exceed the voltage protection rating by 10% percent.

8. 安全预防措施 Safety Precautions

8.1 安装前阅读并理解所有说明。

Read and understand all instructions before installation.

8.2 持续施加在产品上的电压不应超过其最大连续工作电压 U_c 。

The voltage continuously applied to the product should not exceed its maximum continuous working voltage U_c .

8.3 装配时不要用丙酮等溶剂清洗本产品, 以免破坏本产品的封装层。

Avoiding to destroy enclosure, solvent such as acetone is forbidden for cleaning products when assembly.

8.4 装配时应避免出现如敲击等作业方式, 避免造成本产品出现机械损伤。

Avoiding making mechanical damage on products, improper operation such as knocking when assembly is not allowed.

8.5 应用本产品的设备必须有可靠的接地线与大地相连, 地线长度应小于 0.5 米。

Equipment on the use of the products must have reliable grounding to the earth, the length of the grounding wire less than 0.5 m.

8.6 未遵守操作说明可能导致电气系统或相关设备损坏。

If you do not obey the instructions, the electric system or associated equipment may be breakdown.

8.7 安装位置: 室内/室外。

Installation location: Indoors/Outdoors.

- 8.8 系统电压波动范围小于 10%。
Fluctuation range of system voltage shall be less than 10%.
- 8.9 如果 SPD 老化失效，热保护装置断开，工作指示灯熄灭，应立即更换。
The SPD should be replaced immediately when it has the problem of aging failure which would cause the thermal protection device disconnect and the work indicator lights turn off.
- 8.10 安装方式 Mounting Method
采用电源线与被保护设备并联连接。
It employs the parallel connection of the protected device and power cord.

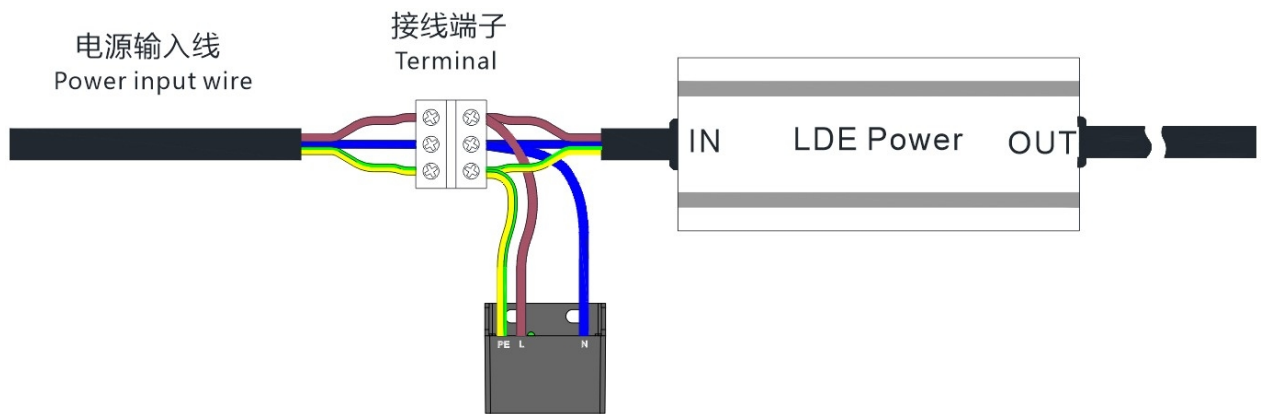

- 注： 1、SPD 的 PE 线应与整机的接地端子连接。
The PE line of SPD should be connected with the earthing terminal of the whole machine.
- 2、如电源输入线缆设置有 PE 线，PE 线应与金属安装板或与整机的接地端子连接。
If the power input cable is provided with PE wire, the PE wire shall be connected with the metal mounting plate or with the grounding terminal of the whole machine.

9. 标示及包装 Marks and Package
 9.1 产品本体标示 Marking on Product

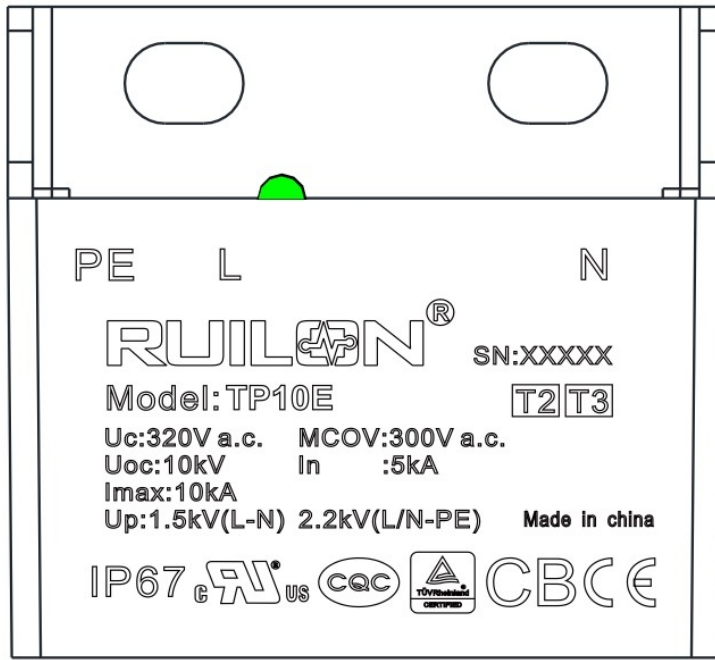

9.2 包装 Packaging

包装方式与要求
 Packaging Method and Requirement

包装尺寸(mm) Dimensions	内盒 Inner Box	外箱 Carton
	382*253*31	395*267*285
数量 (PCS) Quantity	16	160
净重(kg) Net Weight	≈0.712	≈7.12
毛重(kg) Gross Weight	≈0.79	≈8.3

备注:
 Remark:

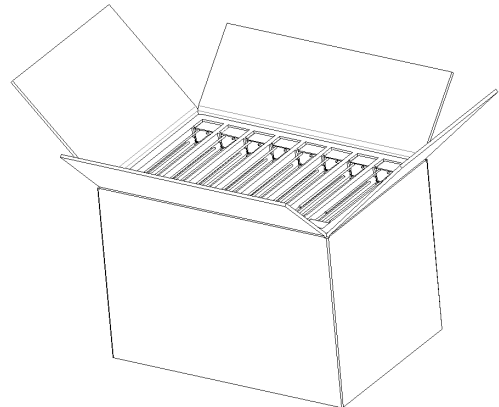
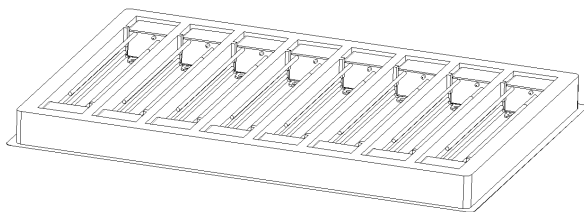

10. 产品批号&追溯号识别 Lot No. & Tracking No. System

大包装追溯号:
Tracking No. on the Outer Package:

Product code(产品代码)	10.20.31.3204-0002
Lot No(批次)	生产批次 Production batch
Product number(产品型号)	TP10E
Quantity (数量)	160



11. 储存条件和有效日期 Storage Conditions and Effective Date

- a) 推荐长期存储条件: 存储温度: (-10 - 40) °C, 存储湿度: ≤75%RH。
Recommend Long-term Storage Condition: Storage Temperature: (-10 - 40) °C, Storage Humidity ≤75%RH.
- b) 不要将本产品存放在有腐蚀性气体或阳光直接照射的环境中。
Do not store the products in the environment that with corrosive gas or under direct sunlight.
- c) 存储期限: 2 年。
Storage Period: 2 years.

12. 有效性 Validity

12.1 修订协议 Agreement of Revision

本规格书的内容若有不充分或需要修订时, 得由两公司协议后再行修订。

If the content of the specifications is inadequate or need revising, it will be revised after agreement by both parties.

12.2 有效性 Validity

本规格书提出后, 于贵公司承认期间, 可暂时使用, 若经过 1 个月后贵公司无异议或未签回规格书时, 则视同有效文件运用。

The specifications can be used temporarily during the period of approval. If you have no any objection or not return one hardcopy to us within 1 month, the specifications will be operated as a valid document.

-以下无正文 END-